

PRODUCT SAFETY

When using electrical equipment, basic safety precautions should always be followed, including the following:



READ THESE INSTRUCTIONS BEFORE USING THIS PRODUCT.



Do not let power supply cords touch hot surfaces.



Do not mount near gas or electric heaters.



Equipment should be mounted in locations and at heights where it will not readily be subjected to tampering by unauthorized personnel.



The use of accessory equipment is not recommended by Encelium as it may cause an unsafe condition.



Do not use this equipment for other than the intended use.



SAVE THESE INSTRUCTIONS.

GETTING STARTED

Overview

Relay Panel is an addressable lighting control panel that allows each relay to be individually controlled and configured to best meet the needs of the facility. Energy management strategies such as smart time scheduling, occupancy control, and daylight harvesting can be deployed through the use of the Relay Panel.

Relay Panel Module is an electronic retrofit module that enables existing relay panels/boxes to be integrated with Encelium X.

MOUNTING OPTION

The Relay Panel Enclosure mounts directly to the wall using screws to secure it into place. Once the enclosure is securely in place, put the cover on the enclosure box and tighten all the screws.

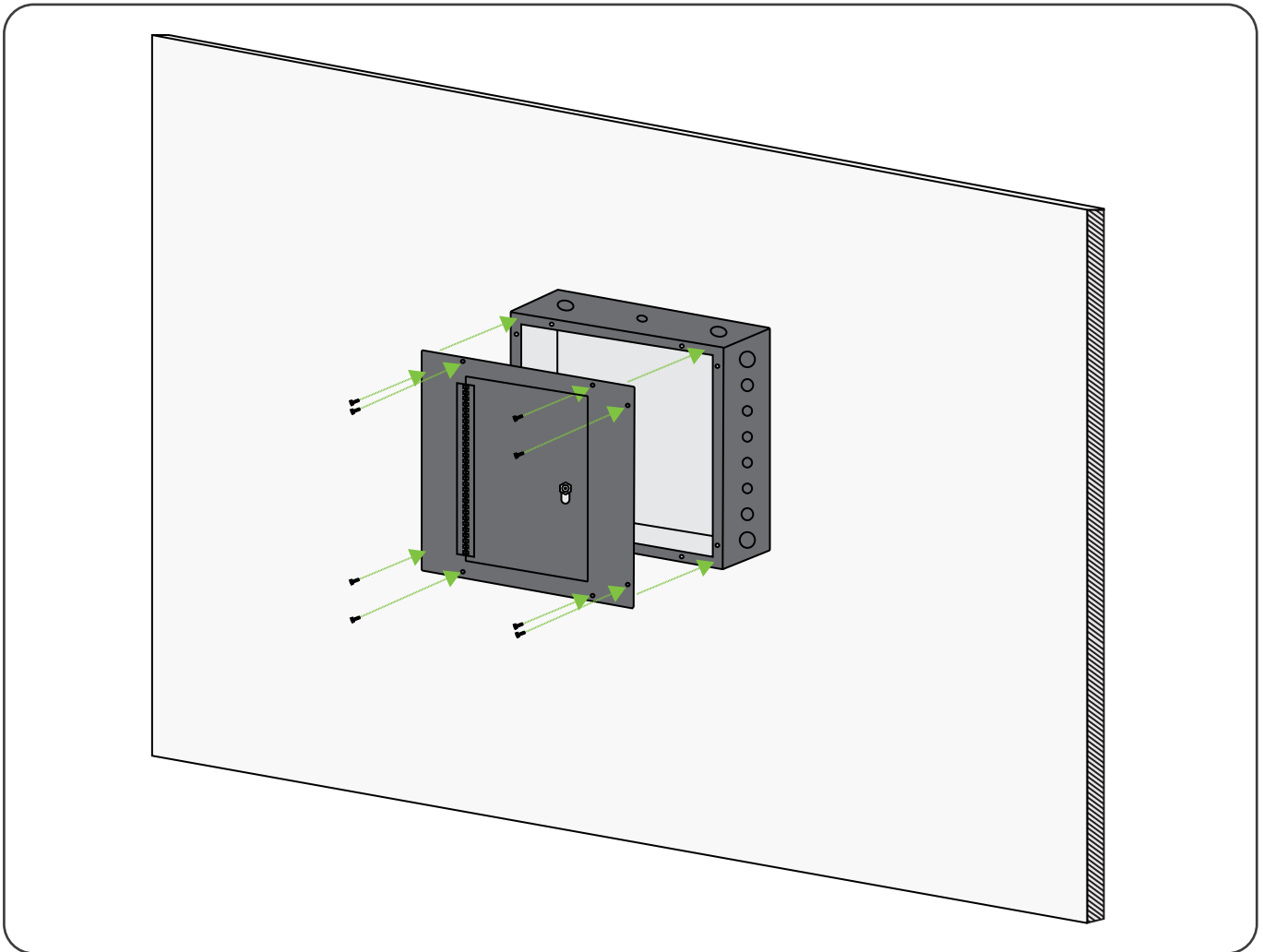

INSTALLATION

- 1 Installation work includes installing the Relay with Relay Panel Module into an appropriate utility space.

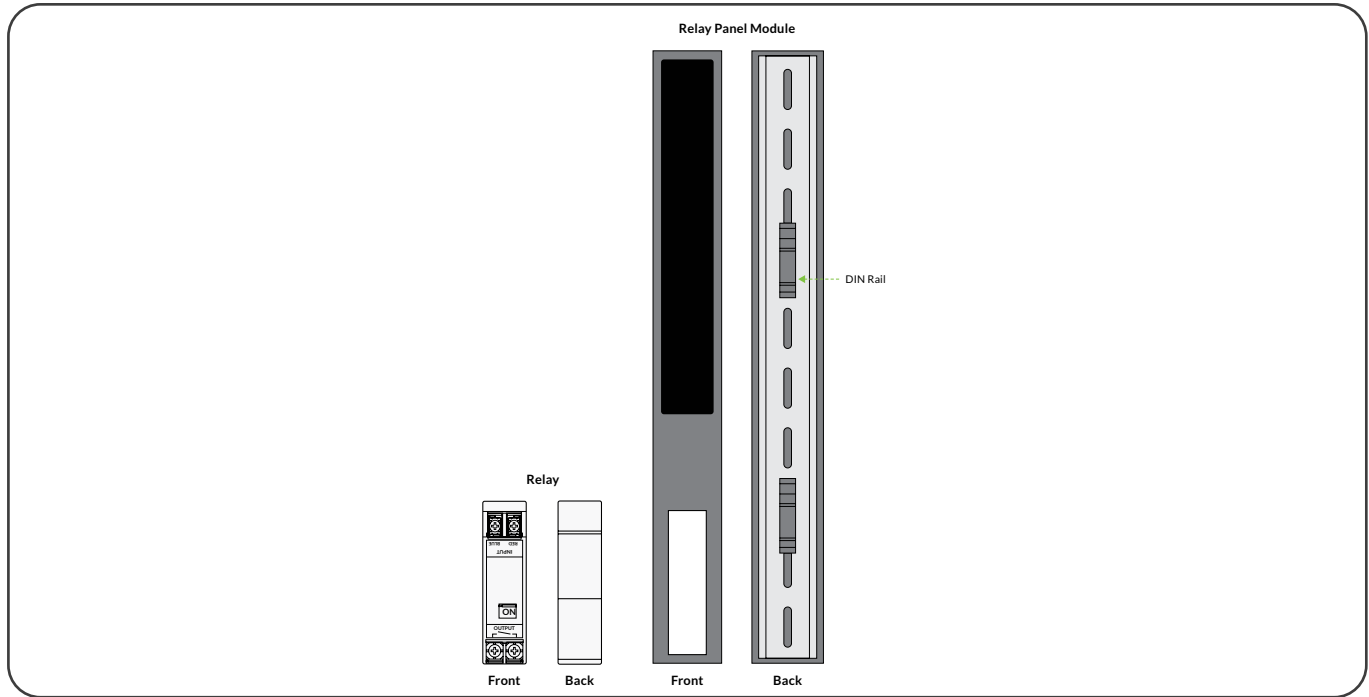

- 2 Make line voltage (120/277/347V) connections to Relays and the Relay Panel Module's two GreenBus connections. Slide the cover of the Relay Panel Module up or down to access the GreenBus connections.

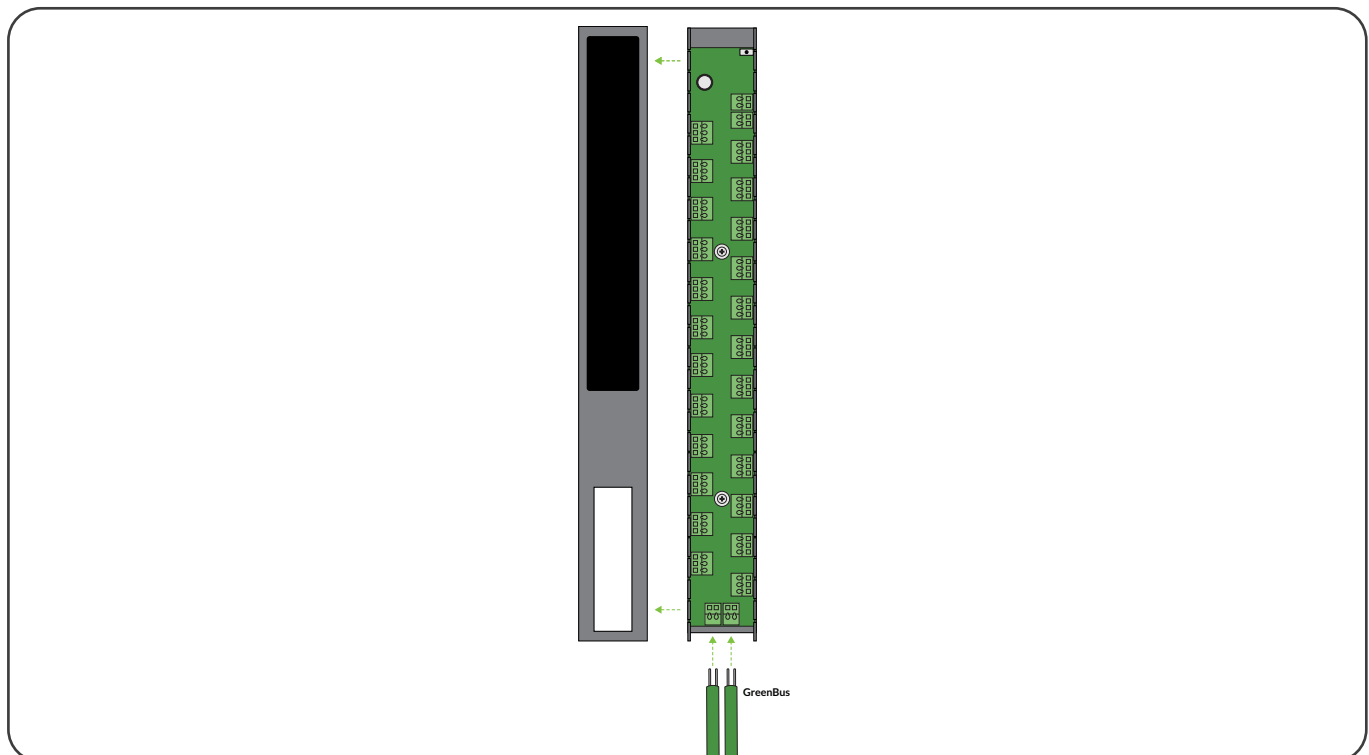

- 3 You can install one Relay Panel Module and up to 24 Relays into the Relay Panel Enclosure.

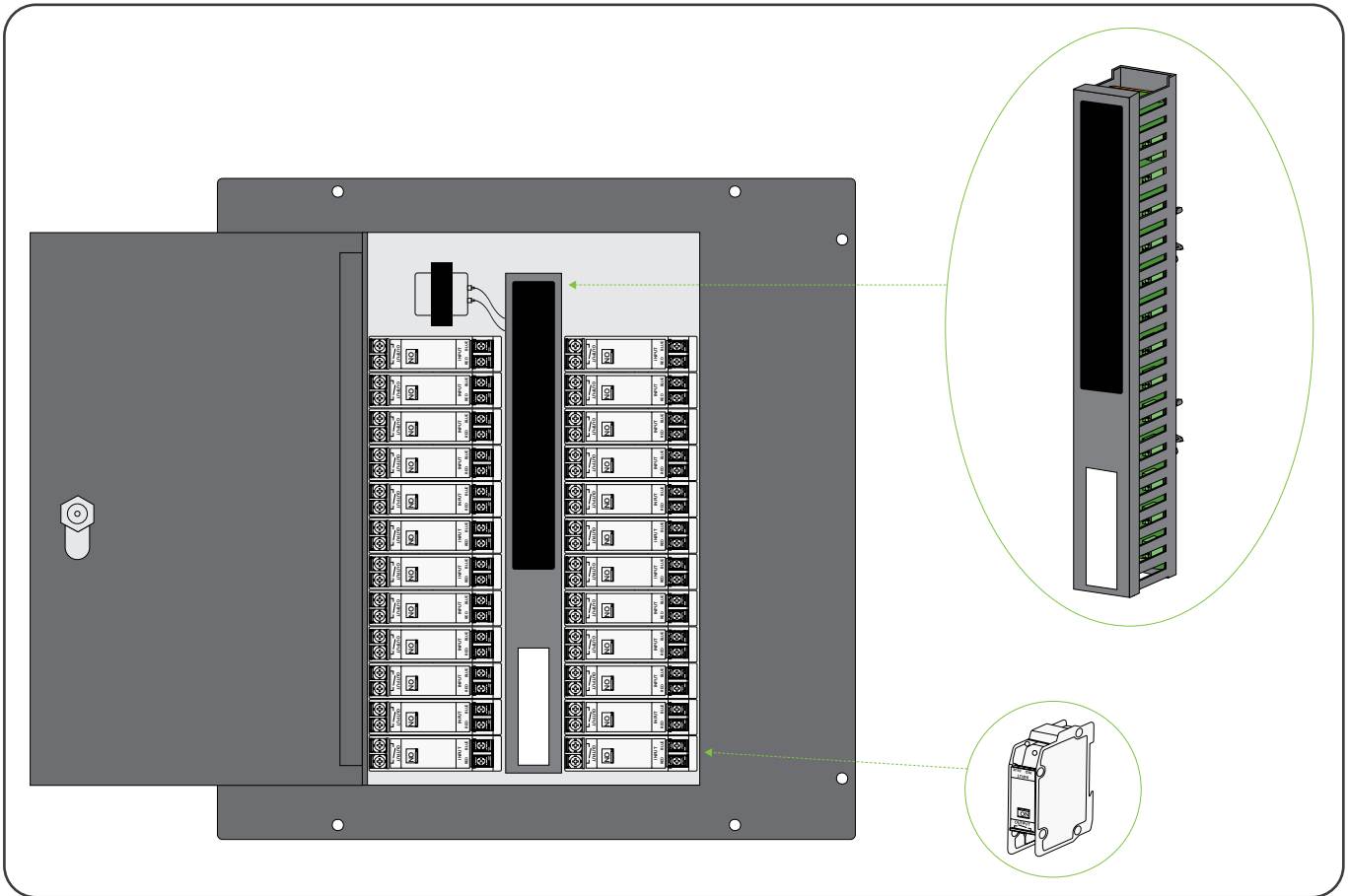

Retrofit Installation

Retrofit Installation work includes retrofitting the Relay Panel Module into the Relay Panel Enclosure and if necessary to supply the Relay Panel Module wiring line voltage power, and making two GreenBus connections. GreenBus connects directly to Relay Panel Module.

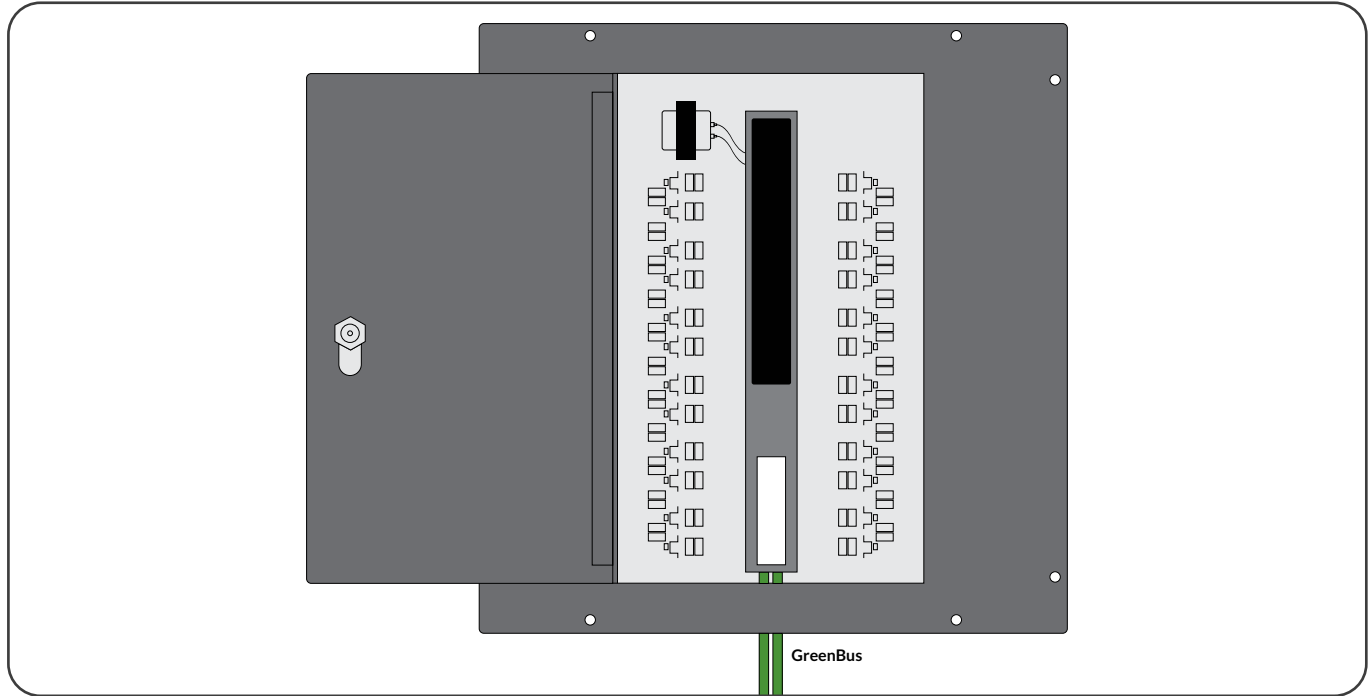

Note: No setting or configuring by the electrical installer is required.

ELECTRICAL CONNECTIONS

1 RPM to Wired Manager – GreenBus Wiring Diagram

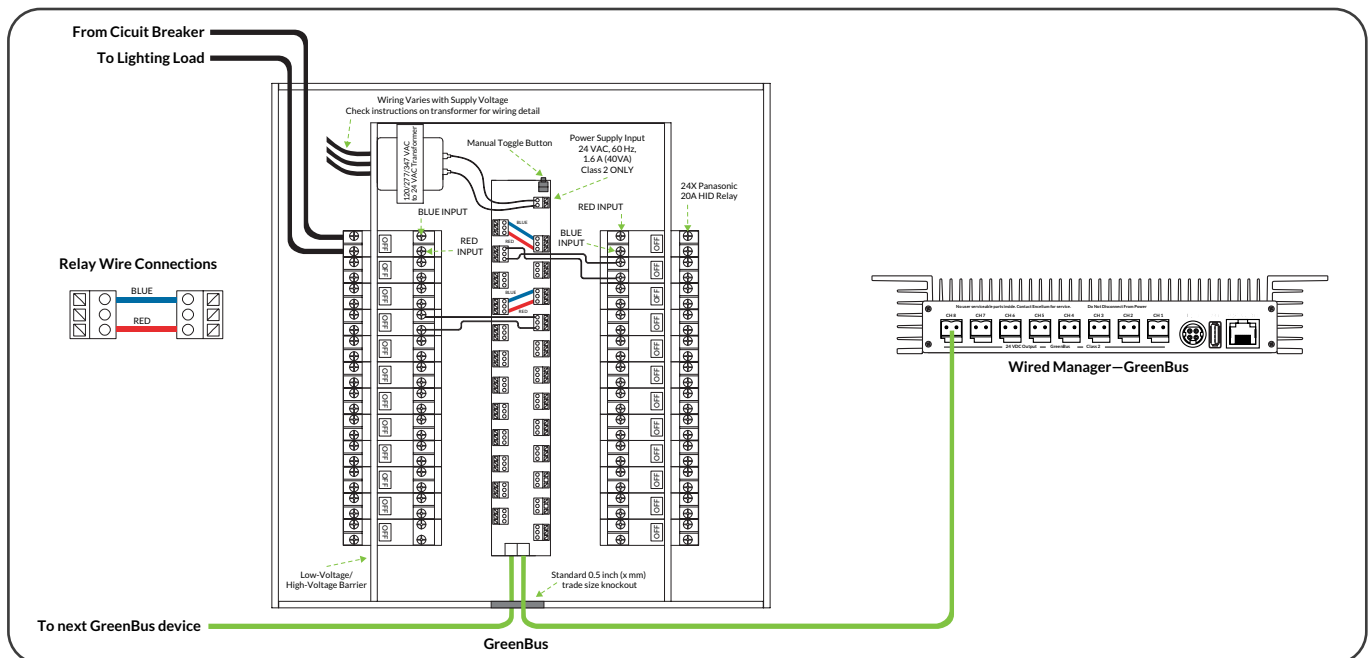

2 RPM Wireless System Integration Wiring Diagram

The RPM can be used as part of a Encelium X Lighting Control System by connecting the Greenbus to a nearby compatible wireless device.

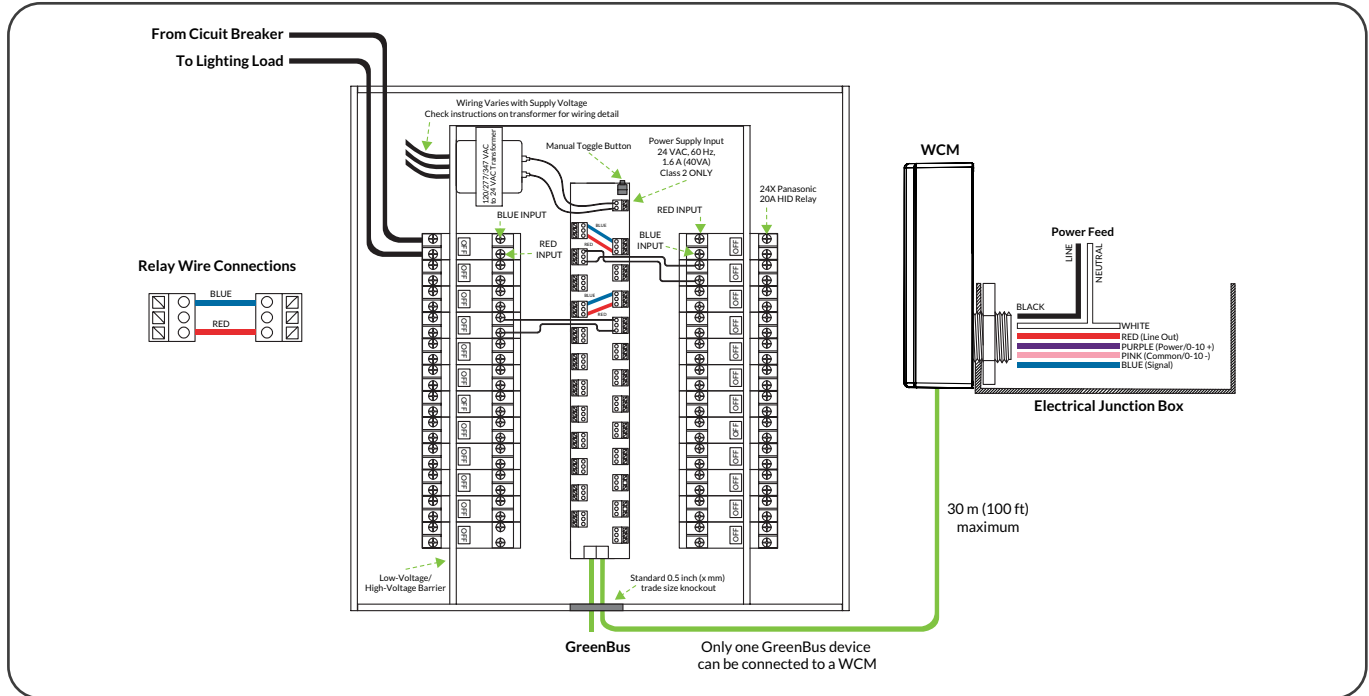

TROUBLESHOOTING

There are no user-serviceable parts inside. For detailed information about how to set-up, install, use, and maintain Encelium hardware and software, please visit: help.encelium.com