

TW Wallstation

Tunable-White Wallstation

Date: _____

Quantity: _____

Company: _____

Project: _____



The **Tunable-White Wallstation** offers the ability to adjust intensity and color temperature from a single wallstation.

The scene buttons come engraved with Warm, Neutral, and Cool making them intuitive for use by occupants.

Works with

- Encelium X
 - ▶ GreenBus Wired
 - ▶ Wireless



Key Features & Benefits

- High aesthetic finish with a sleek design
- Change the color temperature with a press of a single button on a wallstation
- User-programmable scenes with color temperature ranges of 2700 to 6500 K
- Dedicated raise/lower buttons enable finer adjustment for intensity and color temperature
- Can be assigned to a single or multiple zones in a space
- Available in both wired and wireless installations – both with simple installation

Specifications

SENSING AND CONTROL

Control

- GreenBus Communication
- Wireless Communication

Control Options

- Wired devices connect via a 2-wire GreenBus cable
- Wireless devices (battery-operated) connect wirelessly

Communication Ports

- Wired devices connect via a 2-wire GreenBus cable
- Wireless devices (battery-operated) connect wirelessly

ELECTRICAL

Operating Temperature

- -10° to 40°C (14° to 104°F)

Relative Humidity

- 5% to 95% non-condensing, for indoor locations

ENVIRONMENTAL

Ambient Temperature

- Ta maximum 60°C (140°F)

PHYSICAL

Dimensions (H x W x D)

- J-Box Mounted:
114.3 x 70.1 x 23.9 mm (4.5 x 2.76 x 0.94 inches)
- Surface-Mount:
114.3 x 70.1 x 12.7 mm (4.5 x 2.76 x 0.5 inches)

Weight

- 47 g (1.65 oz) – Wired Wallstations
- 51 g (1.8 oz) – Wireless Wallstations

Housing Color

- White

Housing Material

- PC/ABS Plastic

Mounting Options

- Wall Mount
 - ▶ Mounting Bracket (Wired Wallstations Only, Low-Voltage Devices)
 - ▶ Junction Box (Standard Size)
- Surface Mount (Wireless Wallstations Only)
 - ▶ Screw Mount
 - ▶ Adhesive Tape Mount
- “Decora” Style Wall Plate Support

NEMA

- Meets WD 6 and WD 1

WARRANTY

- For warranty details, refer to the full warranty documentation at encelium.com

CERTIFICATIONS & SAFETY

Approbations

- cUL Listed (UL 916)
- FCC Part 15/ICES-003
- RoHS Compliant

Environmental Suitability

- Rated for dry locations

Complies with Electromagnetic Compatibility (EMC) Standards:

- EN 61000-4-2
- EN 61000-4-4
- EN 61000-4-5



GreenBus[®]

Dimensions

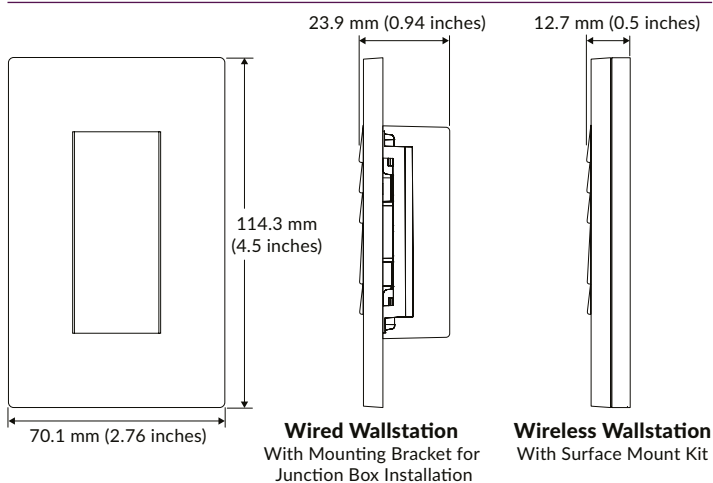

Configuration Options

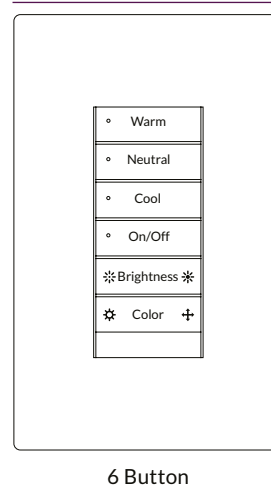

Ordering Information

The 3 Scene Tunable White wallstation offers the ability to adjust intensity and color temperature from a single wallstation. The scene buttons with engravings like Warm, Neutral, Cool make it intuitive for occupants.

GreenBus Wired Wallstation

Catalog Number	Description	Approbations	Communication Network	Modifiers
EN-WS-TWSC3-GB2-WH	TW Wallstation, 3 Button	UL	GreenBus	White – WH

Wireless Wallstation

Catalog Number	Description	Approbations	Communication Network	Modifiers
EN-WS-TWSC3-ZB-WH	TW Wallstation, 3 Button	UL and CE	Wireless	White – WH

Surface-Mount Kit

Catalog Number	Description	Approbations	Communication Network	Modifiers
EN-SMK-ZB-WH	Surface Mount Kit	UL and CE	Wireless	White – WH

Wired System Overview

GreenBus technology makes wiring fast and error-free, since it's intuitive to install. With any Encelium X wired design, you get a reliable, lighting control system that can be installed quickly and easily.

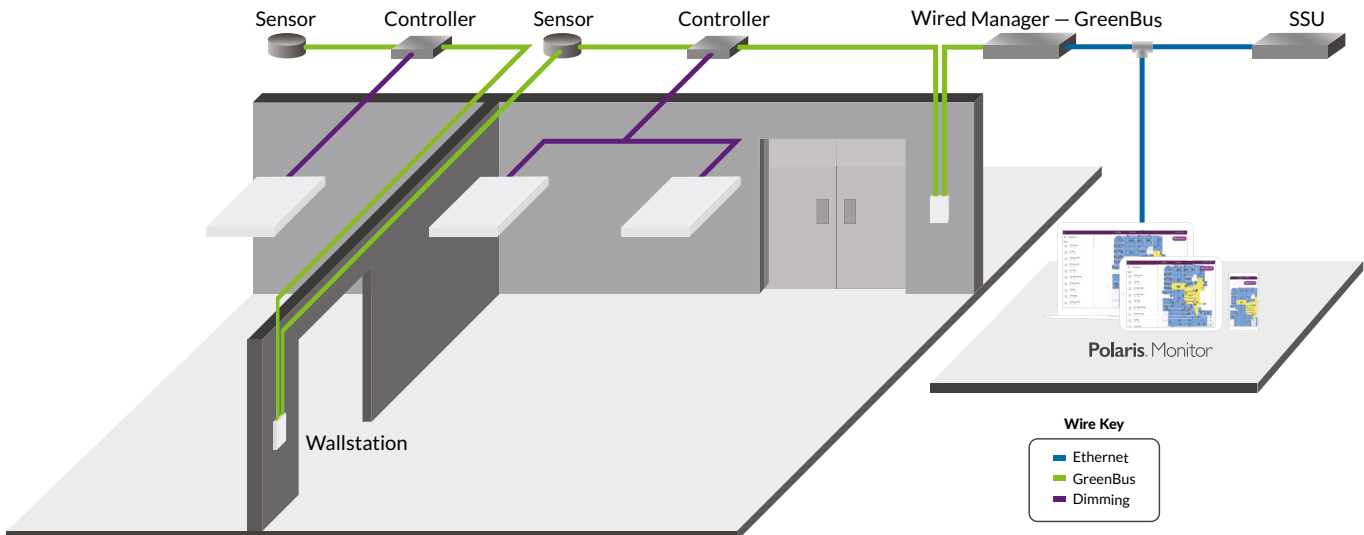

Wireless System Overview

This illustration shows how each component is easily integrated into the Encelium X Lighting Control System.

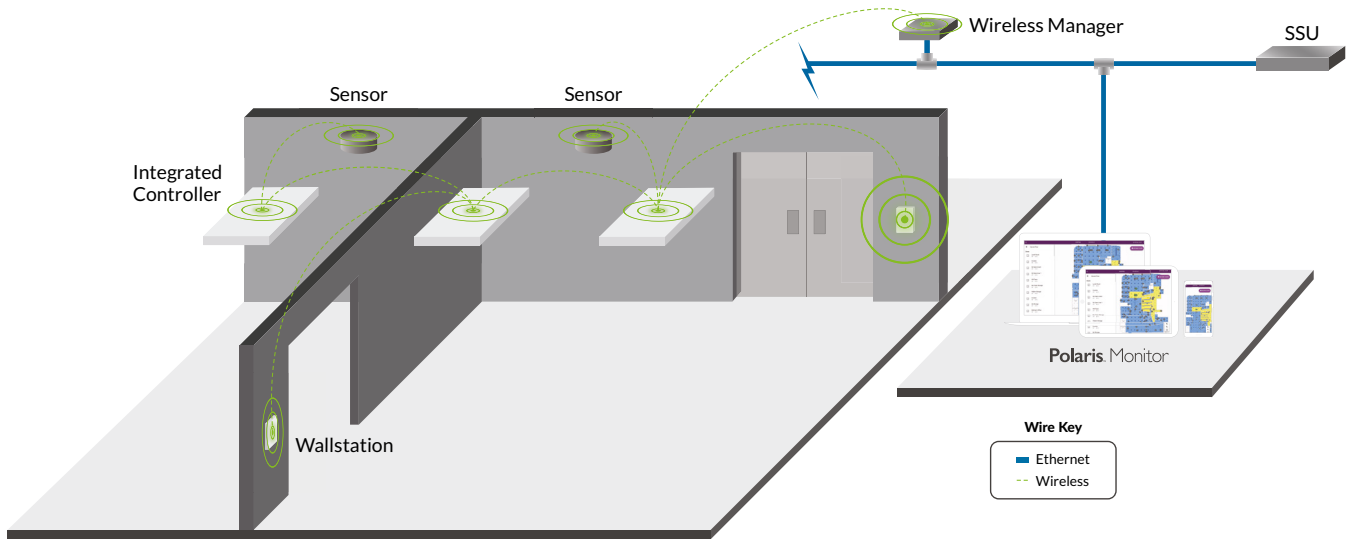

Wiring Diagrams

GreenBus Wired Wallstation Wiring

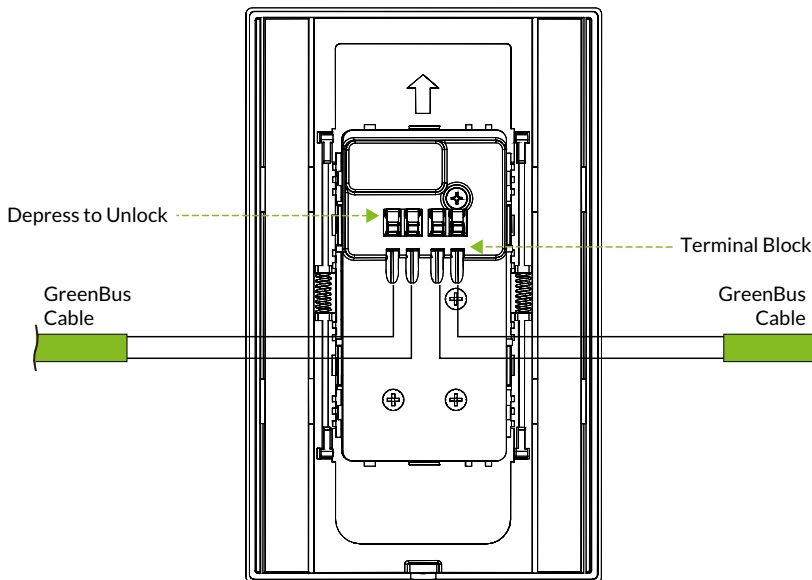

Wiring Diagrams (cont.)

Wireless Wallstation – Battery Operated, No Wiring Required

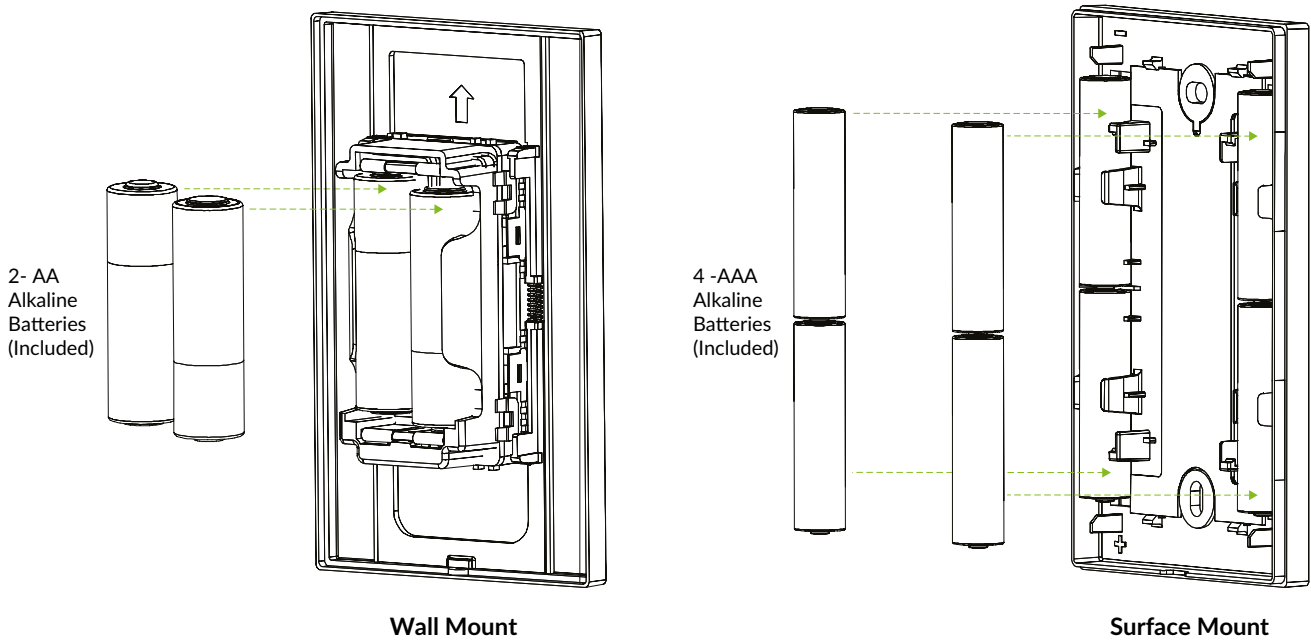

Mounting Options

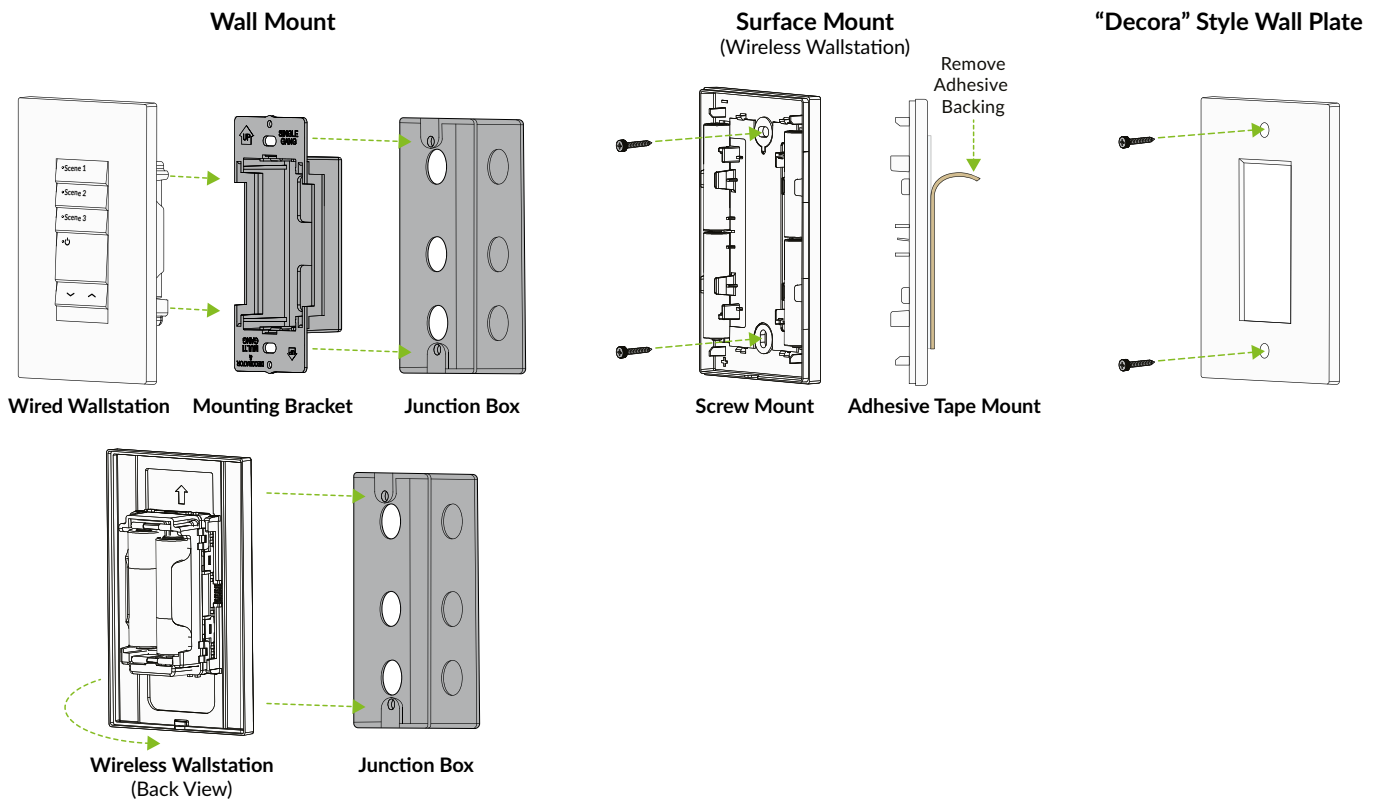

Button Kit Ordering Information

The button kit provides the ability for field replacement. Each part number comes with the three button kits shown to allow flexibility to replace buttons on an existing wallstation.

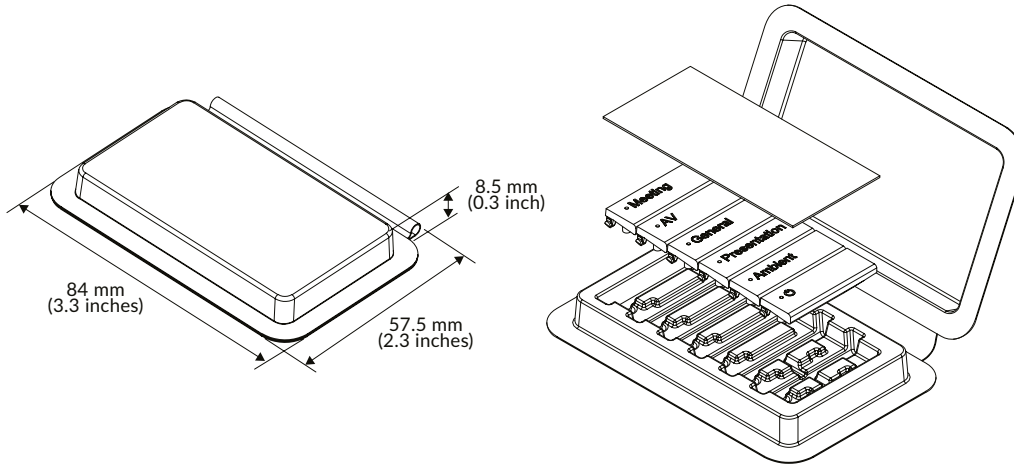

² Custom engraving kits are available. For more information contact your local sales representative.

Ordering Code	Description	Approbations	Buttons	Modifiers			
EN-TW-BT01-ZC3-WH	TW Wallstation, 3 Scene Button Kit	UL and CE	3 - Tunable-White Buttons	White - WH			
	<table border="1"> <tr> <td>◦ Warm</td> </tr> <tr> <td>◦ Neutral</td> </tr> <tr> <td>◦ Cool</td> </tr> </table>	◦ Warm	◦ Neutral	◦ Cool			
◦ Warm							
◦ Neutral							
◦ Cool							