

SHS Wallstation

Shade Control Wallstation

Date: _____

Quantity: _____

Company: _____

Project: _____



The **Shade Control Wallstation** offers the ability to adjust lighting and shades from a single wallstation – giving the occupant a simplified interaction and experience. The Scene buttons allow for recalling pre-defined lighting levels and shade position based on user aesthetics and requirements.

Works with

- Encelium X
 - ▶ GreenBus Wired
 - ▶ Wireless



Key Features & Benefits

- Control lighting and shades with a single user interface
- High aesthetic finish with a sleek design
- Dedicated raise/lower buttons enable finer adjustment of lights and shades
- Can be assigned to a single or multiple zones in a space
- Available in both wired and wireless installations – both with simple installation

Specifications

SENSING AND CONTROL

Control

- GreenBus Communication
- Wireless Communication

Control Options

- Wired devices connect via a 2-wire GreenBus cable
- Wireless devices (battery-operated) connect wirelessly

ELECTRICAL

Operating Temperature

- -10° to 40°C (14° to 104°F)

Relative Humidity

- 5% to 95% non-condensing, for indoor locations

ENVIRONMENTAL

Ambient Temperature

- Ta maximum 60°C (140°F)

PHYSICAL

Dimensions (H x W x D)

- J-Box Mounted:
114.3 x 70.1 x 23.9 mm (4.5 x 2.76 x 0.94 inches)
- Surface-Mount:
114.3 x 70.1 x 12.7 mm (4.5 x 2.76 x 0.5 inches)

Weight

- 47 g (1.65 oz) – Wired Wallstations
- 51 g (1.8 oz) – Wireless Wallstations

Housing Color

- White

Housing Material

- PC/ABS Plastic

Mounting Options

- Wall Mount
 - ▶ Mounting Bracket (Wired Wallstations Only, Low-Voltage Devices)
 - ▶ Junction Box (Standard Size)
- Surface Mount (Wireless Wallstations Only)
 - ▶ Screw Mount
 - ▶ Adhesive Tape Mount
- “Decora” Style Wall Plate Support

NEMA

- Meets WD 6 and WD 1

WARRANTY

- For warranty details, refer to the full warranty documentation at encelium.com

CERTIFICATIONS & SAFETY

Approbations

- cUL Listed (UL 916)
- FCC Part 15/ICES-003
- RoHS Compliant

Environmental Suitability

- Rated for dry locations

Complies with Electromagnetic Compatibility (EMC) Standards:

- EN 61000-4-2
- EN 61000-4-4
- EN 61000-4-5



GreenBus[®]

Dimensions

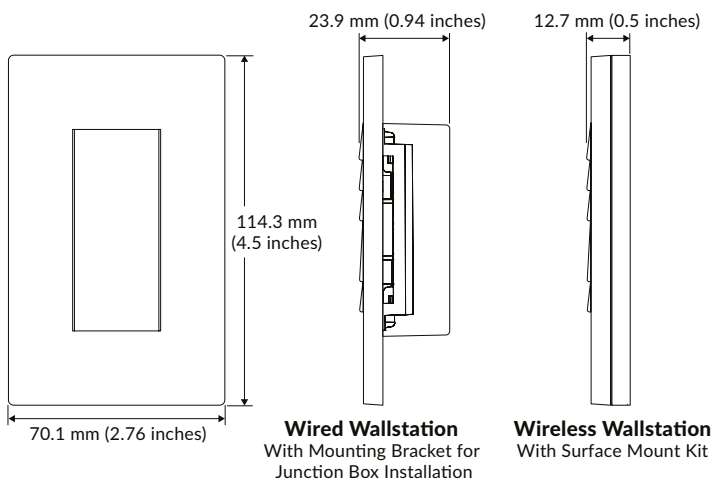

Configuration Options

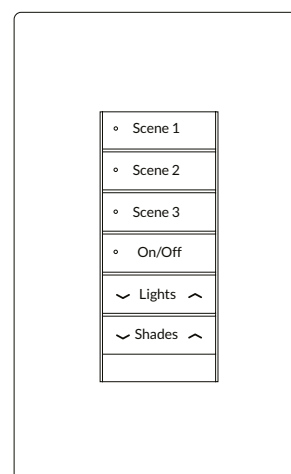

Ordering Information

The 3 Scene Shade Control wallstation offers the ability to adjust lights and shades from a single wallstation. The scene buttons allow for recalling specific lighting level and shade position based on user requirements.

GreenBus Wired Wallstation

Catalog Number	Description	Approbation	Communication Network	Modifiers
EN-WS-SHSC3-GB2-WH	SHS Wallstation, 3 Scene	UL	GreenBus	White – WH

Wireless Wallstation

Catalog Number	Description	Approbation	Communication Network	Modifiers
EN-WS-SHSC3-ZB-WH	SHS Wallstation, 3 Scene	UL	Wireless	White – WH

Surface-Mount Kit

Catalog Number	Description	Approbations	Communication Network	Modifiers
EN-SMK-ZB-WH	Surface Mount Kit	UL and CE	Wireless	White – WH

Wired System Overview

GreenBus technology makes wiring fast and error-free, since it's intuitive to install. With any Encelium X wired design, you get a reliable, lighting control system that can be installed quickly and easily.

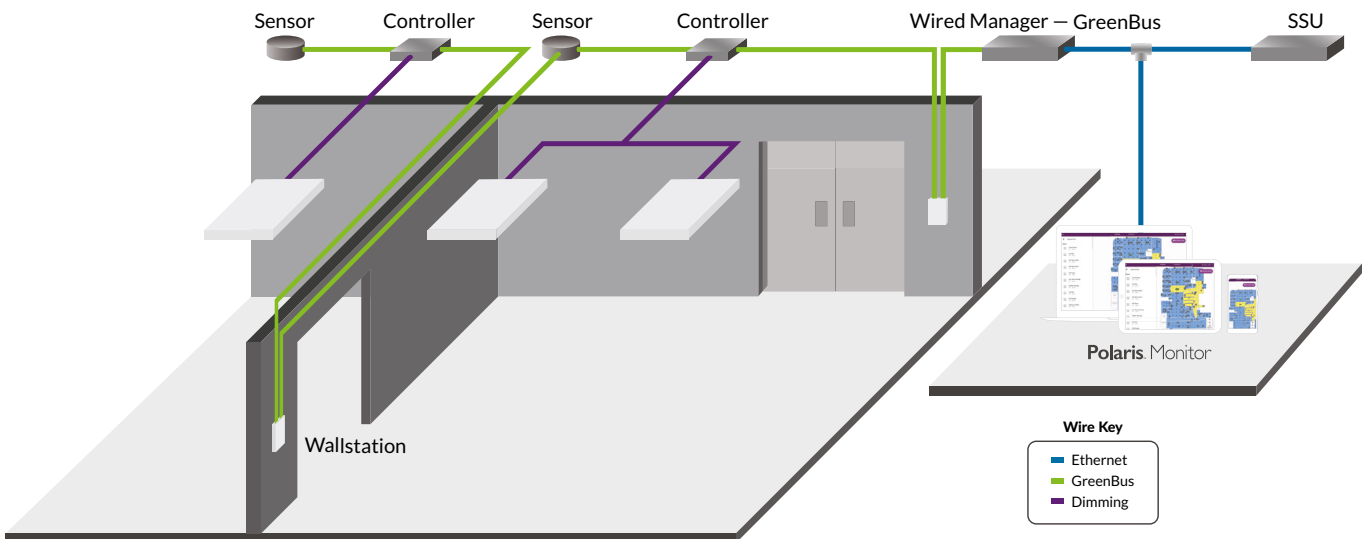

Wireless System Overview

This illustration shows how each component is easily integrated into the Encelium X Lighting Control System.

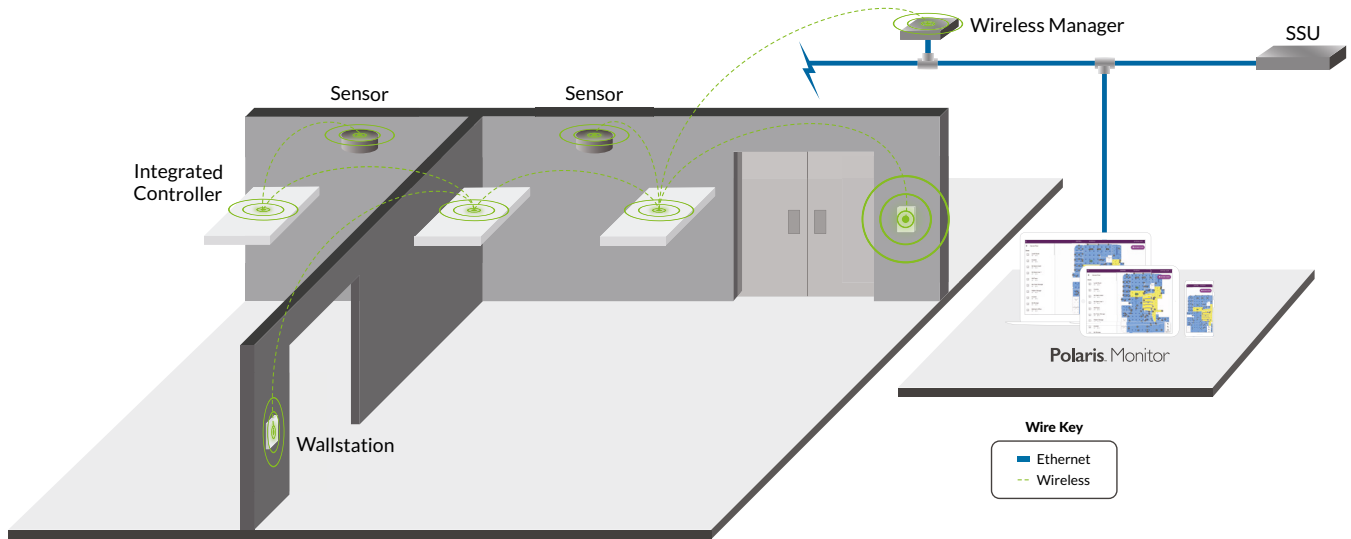

Wiring Diagrams

GreenBus Wired Wallstation Wiring

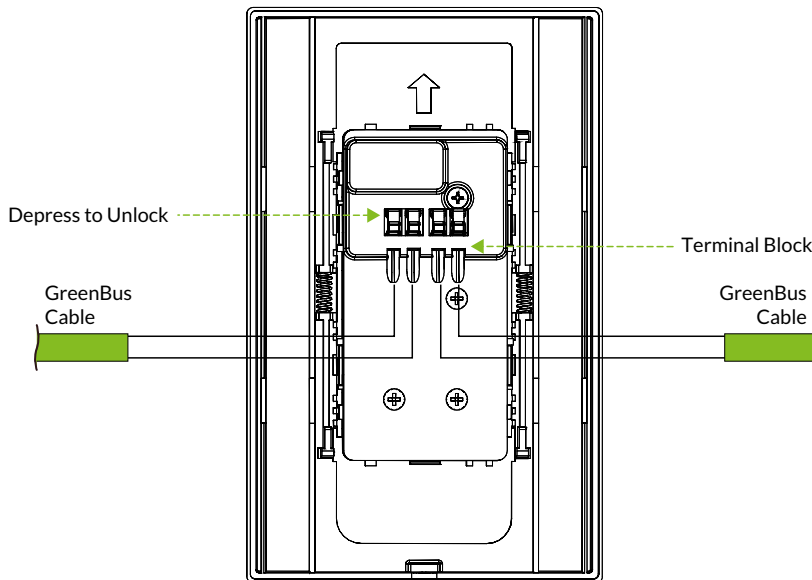

Wiring Diagrams (cont.)

Wireless Wallstation – Battery Operated, No Wiring Required

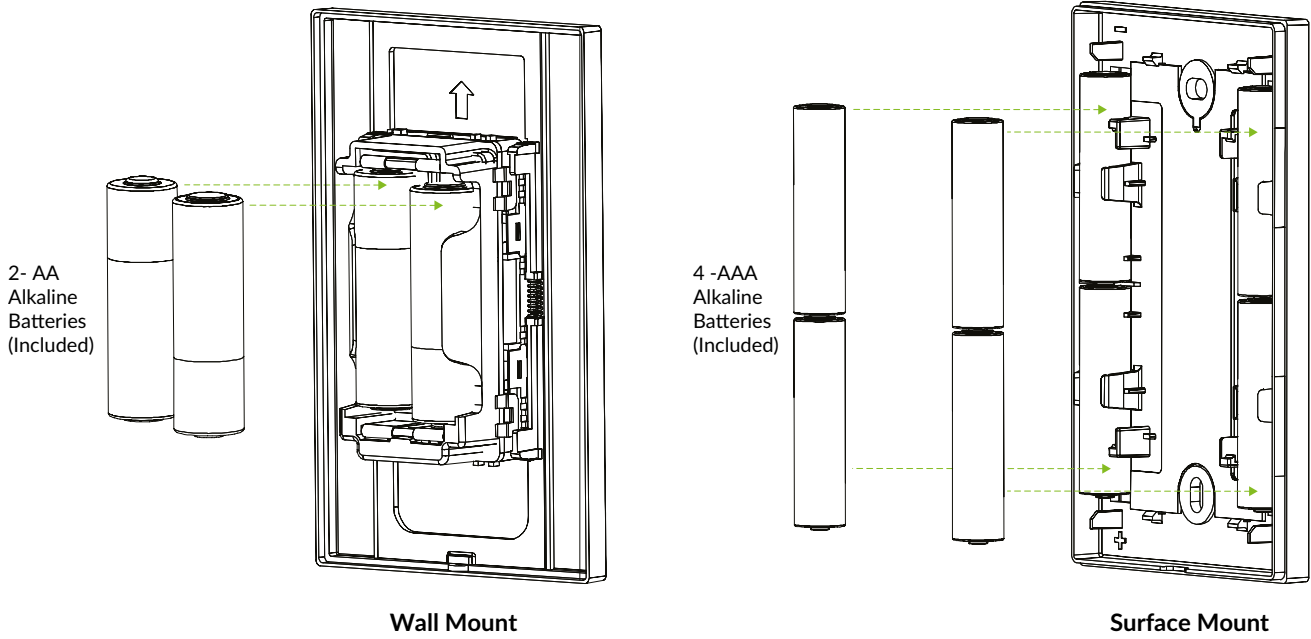

Mounting Options

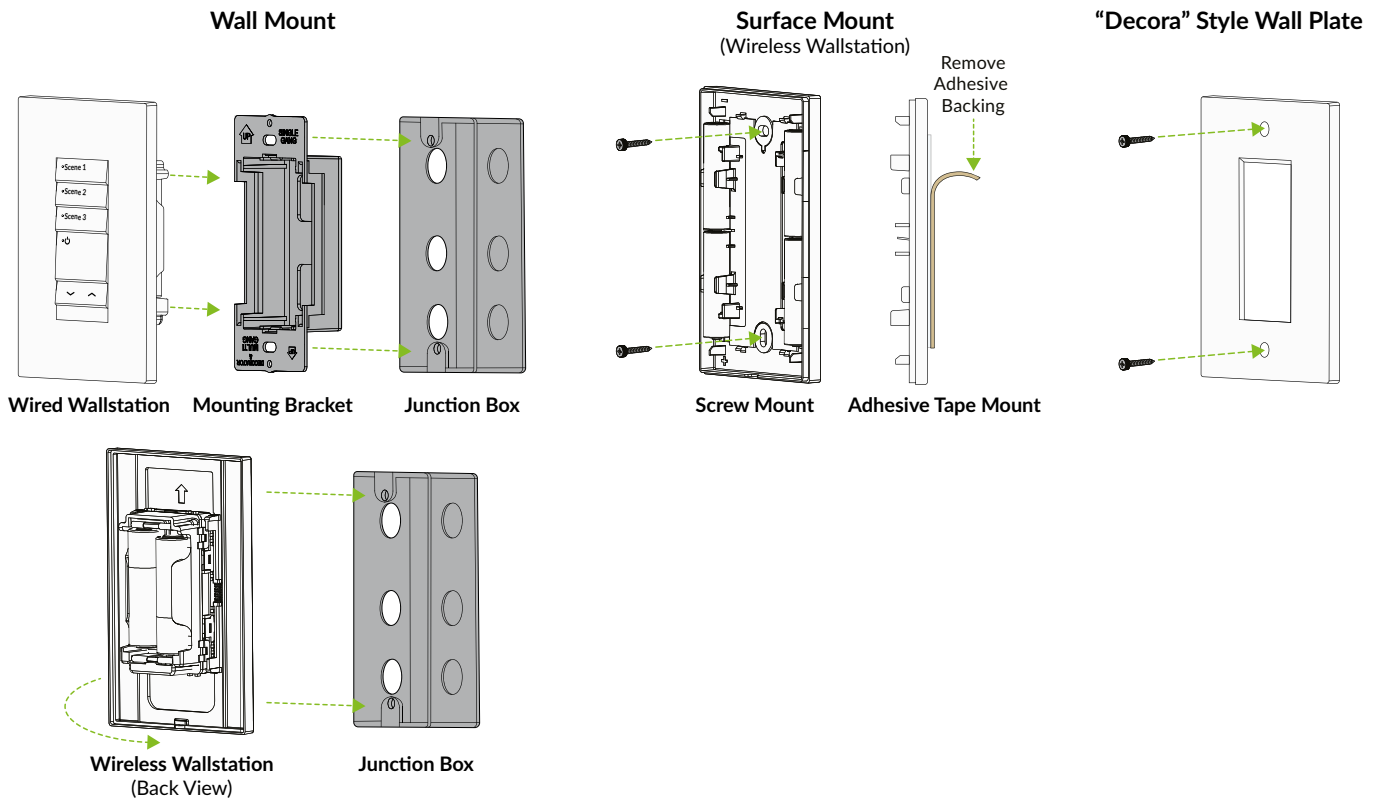

Button Kit Ordering Information

The button kit provides the ability for field replacement. Each part number comes with the three button kits shown to allow flexibility to replace buttons on an existing wallstation.

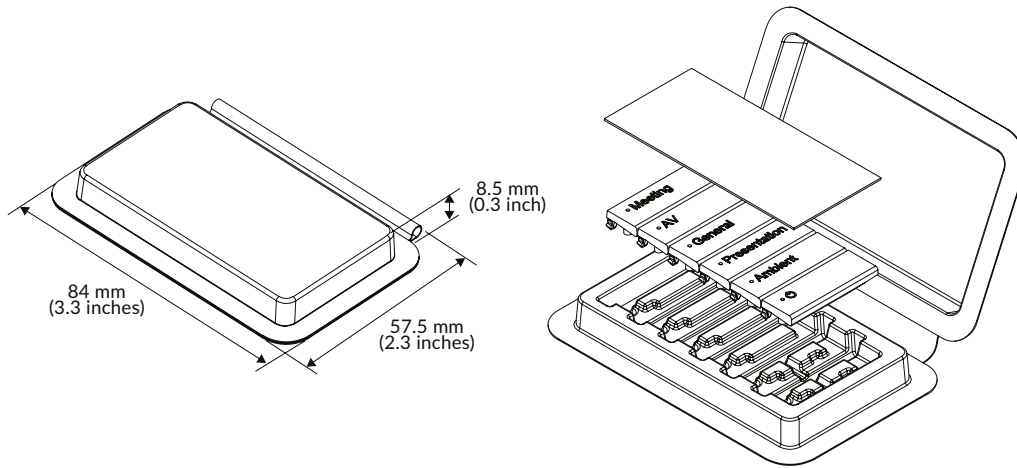

² Custom engraving kits are available. For more information contact your local sales representative.

Catalog Number	Description	Approbation	Buttons	Modifiers
EN-SH-BT01-ZC3-WH	SHS Wallstation, 3 Scene Button Kit	UL	3 - Shade Control Buttons	White - WH

