

SC Series Wallstations

Scene Dimming Wallstation

Date: _____

Quantity: _____

Company: _____

Project: _____



The Encelium **SC Scene Dimming Wallstation** series is a multi-scene, single-zone dimming Wallstation that provides customized light level control in areas such as boardrooms, conference rooms, private offices, and other areas requiring architectural dimming.

The SC Series allows the user to select pre-programmed light levels or “scenes” with the push of a button. Scene configuration can be changed via Polaris Software.

The SC Series Wallstations are available in Wired and Wireless designs with multiple color aesthetics to suit a range of applications.

Works with

- Encelium X
 - ▶ GreenBus Wired
 - ▶ Wireless



Key Features & Benefits

- Available in either 3 Scene or 5 Scene configuration options
- The sleek, aesthetic designs are suitable for all interior locations
- Available in White, Ivory, Gray, and Black to suit a range of interior designs
- Available in both Wireless and Wired versions with simple installation with tool-less mounting
- Setup and configuration via Polaris™ software
- Wireless wallstation offer 10-year battery life with automatic battery monitoring via Polaris software

ENCELIUM

Specifications

SENSING AND CONTROL

Control

- GreenBus Communication
- Wireless Communication

Control Options

- Wired devices connect via a 2-wire GreenBus cable
- Wireless devices (battery-operated) connect wirelessly

ELECTRICAL

Operating Temperature

- -10° to 40°C (14° to 104°F)

Relative Humidity

- 5% to 95% non-condensing, for indoor locations

ENVIRONMENTAL

Ambient Temperature

- Ta maximum 60°C (140°F)

PHYSICAL

Dimensions (H x W x D)

- J-Box Mounted:
114.3 x 70.1 x 23.9 mm (4.5 x 2.76 x 0.94 inches)
- Surface-Mount:
114.3 x 70.1 x 12.7 mm (4.5 x 2.76 x 0.5 inches)

Weight

- 47 g (1.65 oz) – Wired Wallstations
- 51 g (1.8 oz) – Wireless Wallstations

Housing Colors

- White
- Ivory
- Gray
- Black

Housing Material

- PC/ABS Plastic

Mounting Options

- Wall Mount
 - ▶ Mounting Bracket (Wired Wallstations Only, Low-Voltage Devices)
 - ▶ Junction Box (Standard Size)
- Surface Mount (Wireless Wallstations Only)
 - ▶ Screw Mount
 - ▶ Adhesive Tape Mount
- “Decora” Style Wall Plate Support

NEMA

- Meets WD 6 and WD 1

WARRANTY

- For warranty details, refer to the full warranty documentation at encelium.com

CERTIFICATIONS & SAFETY

Approbations

- cUL Listed (UL 916)
- CE
- FCC Part 15/ICES-003
- RoHS Compliant

Environmental Suitability

- Rated for dry locations

Complies with Electromagnetic Compatibility (EMC) Standards:

- EN 61000-4-2
- EN 61000-4-4
- EN 61000-4-5



GreenBus.

Dimensions

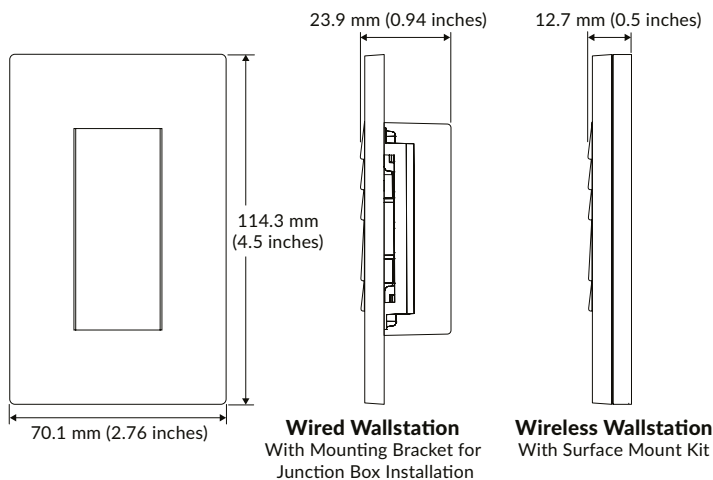

Configuration Options

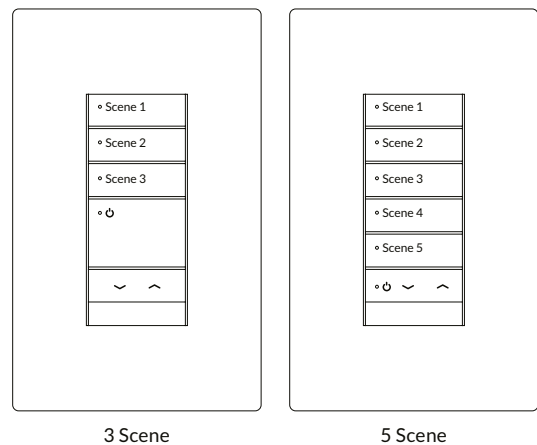

Ordering Information

GreenBus Wired Wallstations

Catalog Number	Description	Approbation	Communication Network	Modifiers
EN-WS-SC3-GB2-WH	SC Series Wallstation, 3 Scene	UL	GreenBus	White – WH
EN-WS-SC3-GB2-IV	SC Series Wallstation, 3 Scene	UL	GreenBus	Ivory – IV
EN-WS-SC3-GB2-GR	SC Series Wallstation, 3 Scene	UL	GreenBus	Gray – GR
EN-WS-SC3-GB2-BL	SC Series Wallstation, 3 Scene	UL	GreenBus	Black – BL
EN-WS-SC5-GB2-WH	SC Series Wallstation, 5 Scene	UL	GreenBus	White – WH
EN-WS-SC5-GB2-IV	SC Series Wallstation, 5 Scene	UL	GreenBus	Ivory – IV
EN-WS-SC5-GB2-GR	SC Series Wallstation, 5 Scene	UL	GreenBus	Gray – GR
EN-WS-SC5-GB2-BL	SC Series Wallstation, 5 Scene	UL	GreenBus	Black – BL

Wireless Wallstations

Catalog Number	Description	Approbations	Communication Network	Modifiers
EN-WS-SC3-ZB-WH	SC Series Wallstation, 3 Scene	UL and CE	Wireless	White – WH
EN-WS-SC3-ZB-IV	SC Series Wallstation, 3 Scene	UL and CE	Wireless	Ivory – IV
EN-WS-SC3-ZB-GR	SC Series Wallstation, 3 Scene	UL and CE	Wireless	Gray – GR
EN-WS-SC3-ZB-BL	SC Series Wallstation, 3 Scene	UL and CE	Wireless	Black – BL
EN-WS-SC5-ZB-WH	SC Series Wallstation, 5 Scene	UL and CE	Wireless	White – WH
EN-WS-SC5-ZB-IV	SC Series Wallstation, 5 Scene	UL and CE	Wireless	Ivory – IV
EN-WS-SC5-ZB-GR	SC Series Wallstation, 5 Scene	UL and CE	Wireless	Gray – GR
EN-WS-SC5-ZB-BL	SC Series Wallstation, 5 Scene	UL and CE	Wireless	Black – BL

Surface-Mount Kit

Catalog Number	Description	Approbations	Communication Network	Modifiers
EN-SMK-ZB-WH	Surface Mount Kit	UL and CE	Wireless	White – WH

Wired System Overview

GreenBus technology makes wiring fast and error-free, since it's intuitive to install. With any Encelium X wired design, you get a reliable, lighting control system that can be installed quickly and easily.

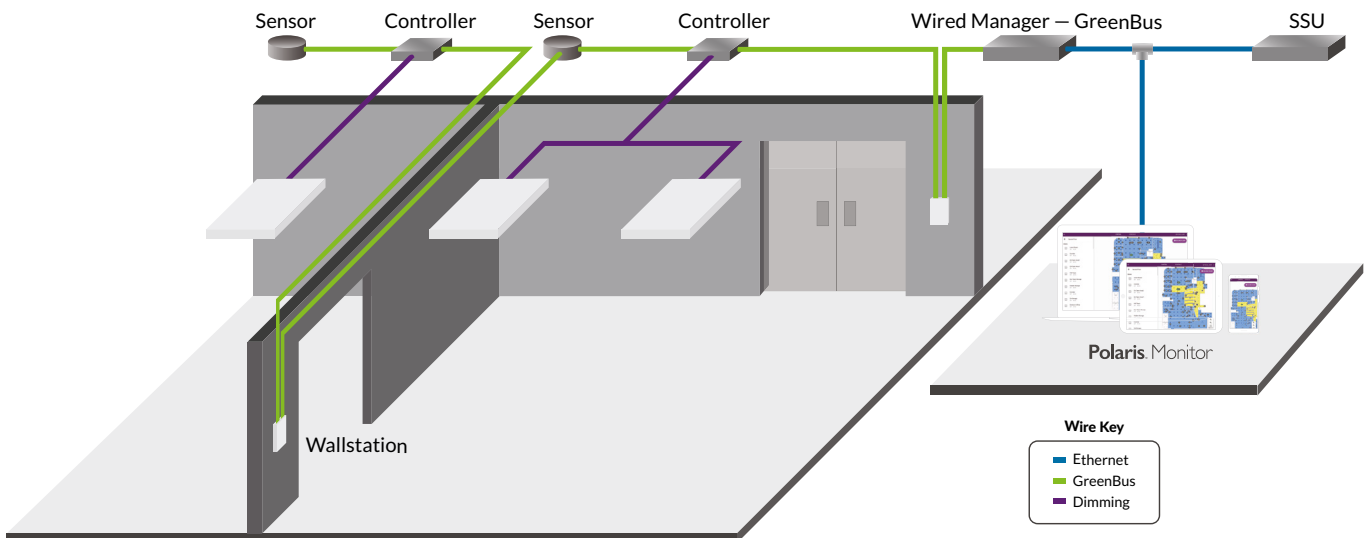

Wireless System Overview

This illustration shows how each component is easily integrated into the Encelium X Lighting Control System.

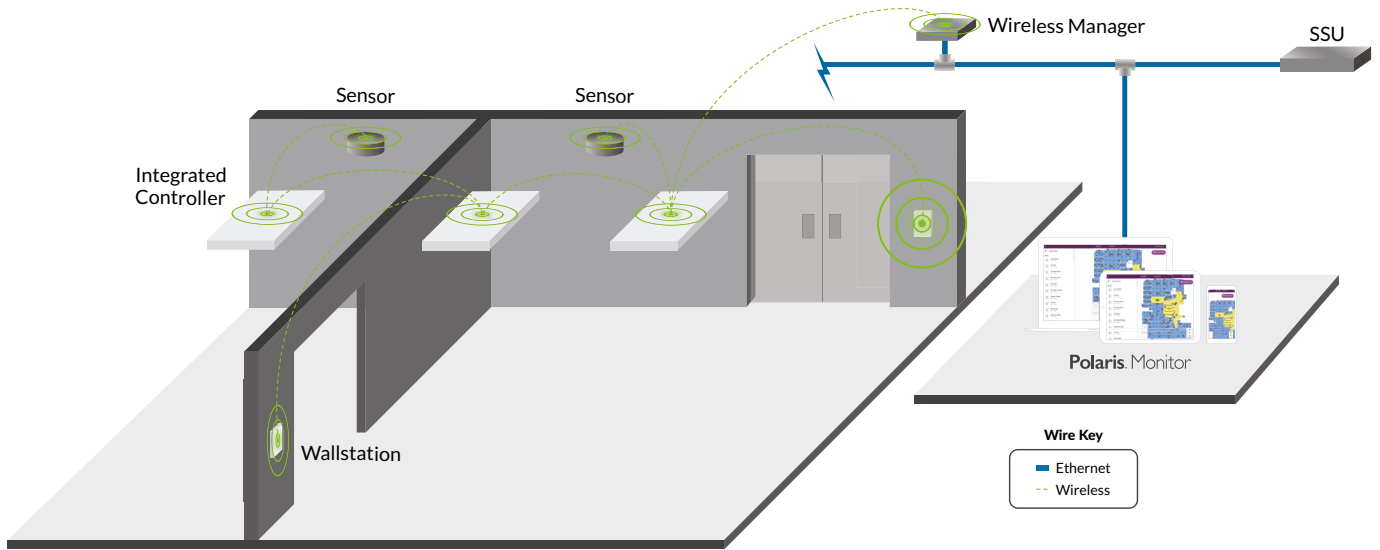

Wiring Diagrams

GreenBus Wired Wallstation

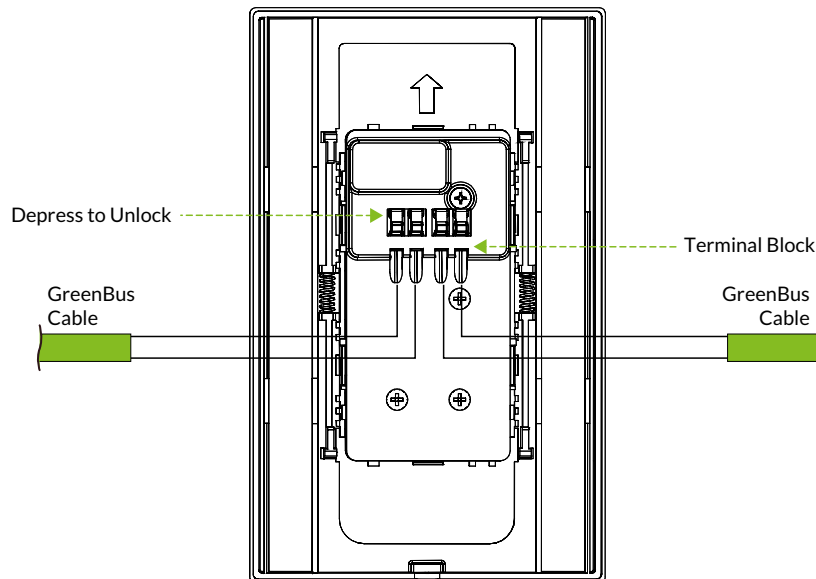

Wiring Diagrams (cont.)

Wireless Wallstation – Battery Operated, No Wiring Required

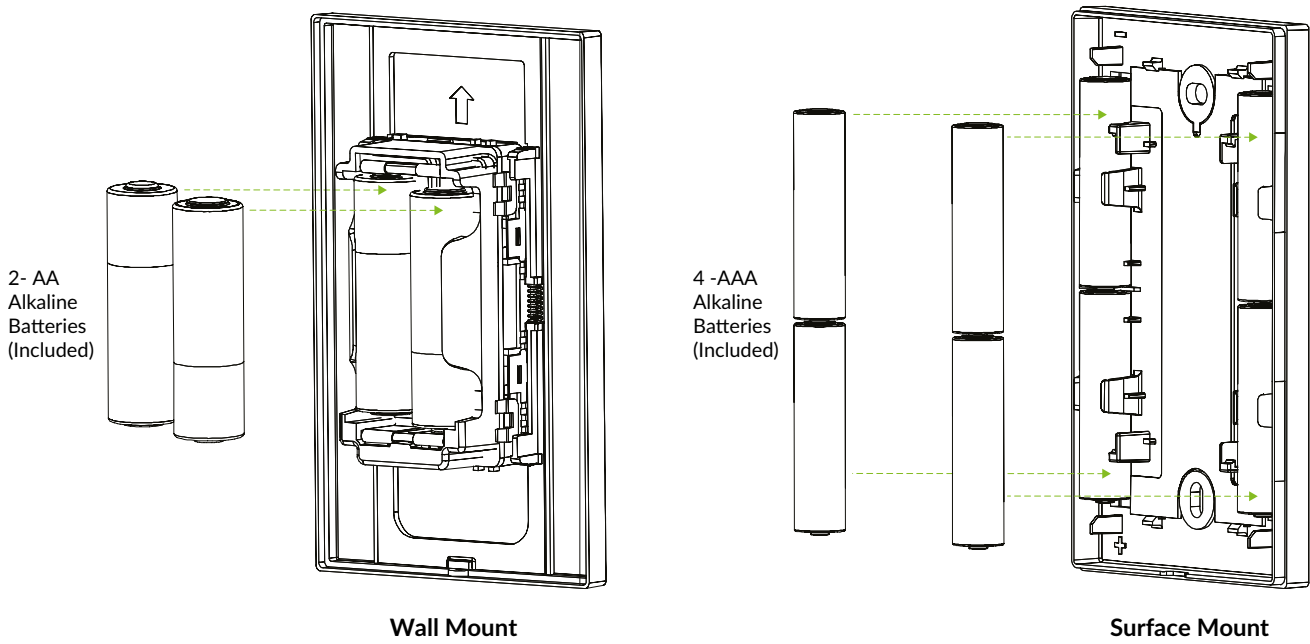

Mounting Options

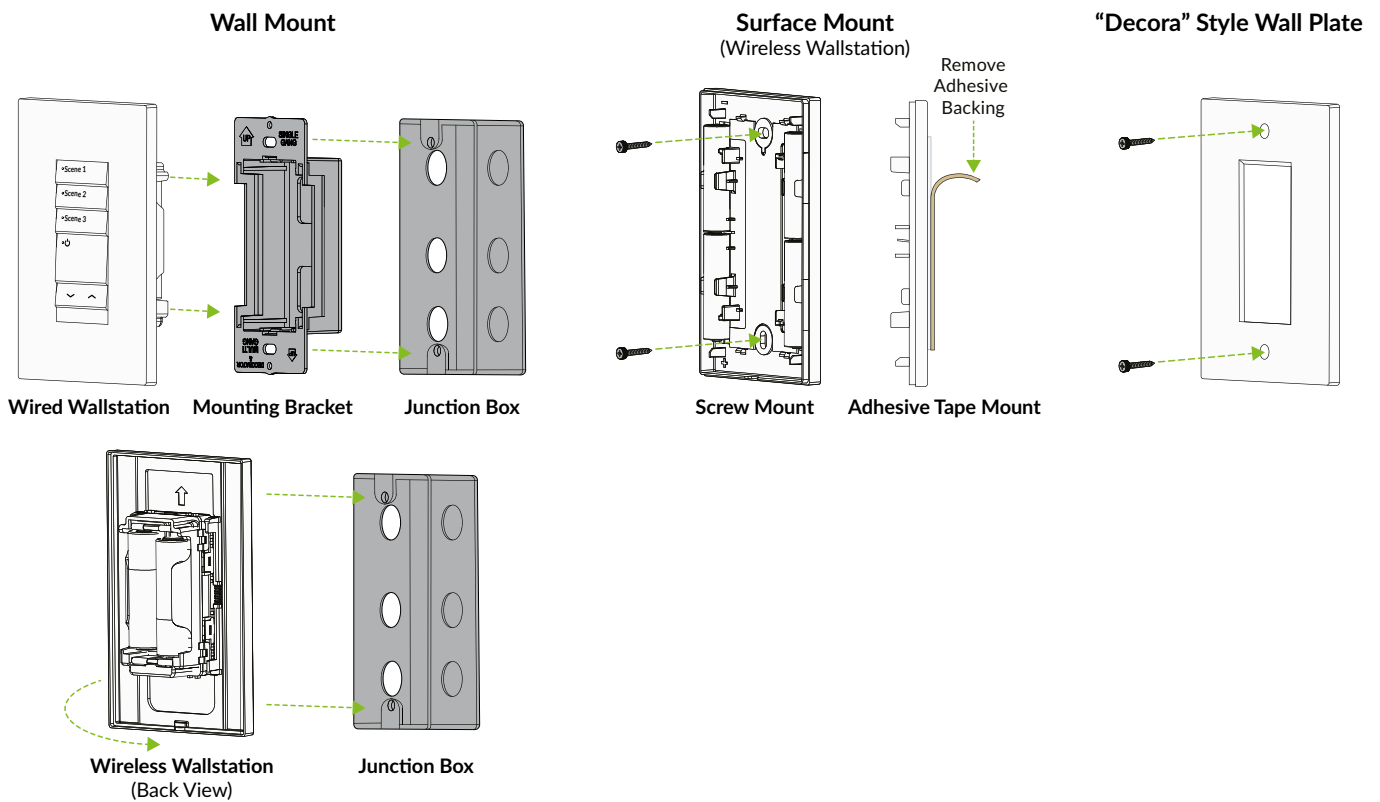

Button Kit Ordering Information

The button kit provides the ability for field replacement. Each part number comes with the three button kits shown to allow flexibility to replace buttons on an existing wallstation.

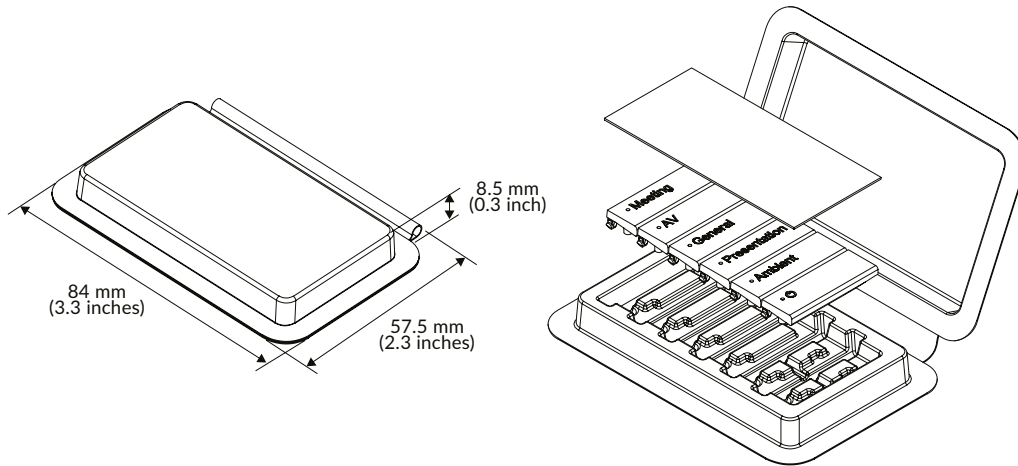

² Custom engraving kits are available. For more information contact your local sales representative.

Catalog Number	Description	Approbations	Buttons	Modifiers
EN-BLANK-BT01-SH-WH	SC Series Wallstation, Blank, 5 Scene Button Kit	UL and CE	3 sets of 5 Single Height Buttons	White - WH
	