

# ZC Series Wallstations

## Multi-Zone Controller Wallstation Series

Date: \_\_\_\_\_

Quantity: \_\_\_\_\_

Company: \_\_\_\_\_

Project: \_\_\_\_\_



The Encelium **ZC Zone Controller Wallstation** series is a multi-zone Wallstation that offers software configurable lighting control that provides ON/OFF switching for multiple lighting zones. The ZC Series are generally located at entry points to a floor or department and are used to activate or de-activate a lighting zone.

Wireless Wallstations enable convenient control and desired lighting levels by communicating user inputs to an Encelium Wireless Manager. The ZC Series are generally located at entry points to a floor or department and are used to activate or de-activate a lighting zone.

The ZC Wired Wallstations are low-voltage and connect to the Encelium X Lighting Control System through a GreenBus™ cable with 2-pin connectors.

### Works with

- Encelium X
  - ▶ GreenBus Wired
  - ▶ Wireless



### Key Features & Benefits

- Available in either 3 Zone or 6 Zone configuration options
- The sleek, aesthetic designs are suitable for all interior locations
- Available in White, Ivory, Gray, and Black to suit a range of interior designs
- Available in both Wireless and Wired versions with simple installation with tool-less mounting
- Setup and configuration via Polaris™ software
- Wireless wallstation offer 10-year battery life with automatic battery monitoring via Polaris software

# ENCELIUM

# Specifications

## SENSING AND CONTROL

### Control

- GreenBus Communication
- Wireless Communication

### Control Options

- Wired devices connect via a 2-wire GreenBus cable
- Wireless devices (battery-operated) connect wirelessly

### Communication Ports

- Wired devices connect via a 2-wire GreenBus cable
- Wireless devices (battery-operated) connect wirelessly

## ELECTRICAL

### Operating Temperature

- -10° to 40°C (14° to 104°F)

### Relative Humidity

- 5% to 95% non-condensing, for indoor locations

## ENVIRONMENTAL

### Ambient Temperature

- Ta maximum 60°C (140°F)

## PHYSICAL

### Dimensions (H x W x D)

- J-Box Mounted:  
114.3 x 70.1 x 23.9 mm (4.5 x 2.76 x 0.94 inches)
- Surface-Mount:  
114.3 x 70.1 x 12.7 mm (4.5 x 2.76 x 0.5 inches)

### Weight

- 47 g (1.65 oz) – Wired Wallstations
- 51 g (1.8 oz) – Wireless Wallstations

### Housing Colors

- White
- Ivory
- Gray
- Black

## Housing Material

- PC/ABS Plastic

## Mounting Options

- Wall Mount
  - ▶ Mounting Bracket (Wired Wallstations Only, Low-Voltage Devices)
  - ▶ Junction Box (Standard Size)
- Surface Mount (Wireless Wallstations Only)
  - ▶ Screw Mount
  - ▶ Adhesive Tape Mount
- “Decora” Style Wall Plate Support

## NEMA

- Meets WD 6 and WD 1

## WARRANTY

- For warranty details, refer to the full warranty documentation at [encelium.com](http://encelium.com)

## CERTIFICATIONS & SAFETY

### Approbations

- cUL Listed (UL 916)
- FCC Part 15/ICES-003
- RoHS Compliant

### Environmental Suitability

- Rated for dry locations

### Complies with Electromagnetic Compatibility (EMC) Standards:

- EN 61000-4-2
- EN 61000-4-4
- EN 61000-4-5



GreenBus.

## Dimensions

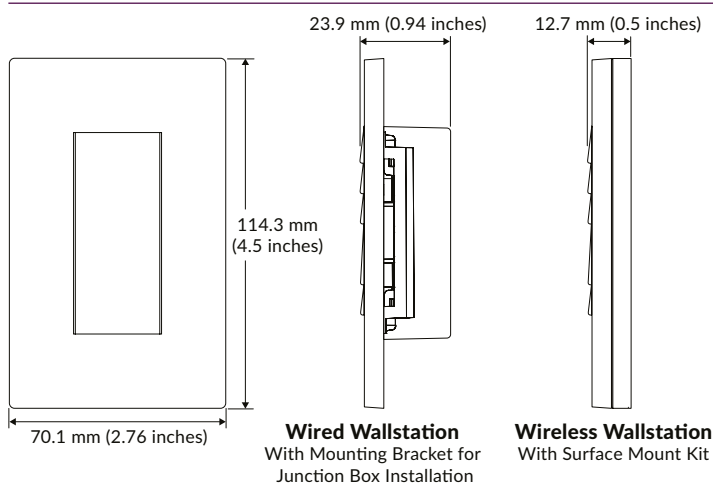

## Configuration Options

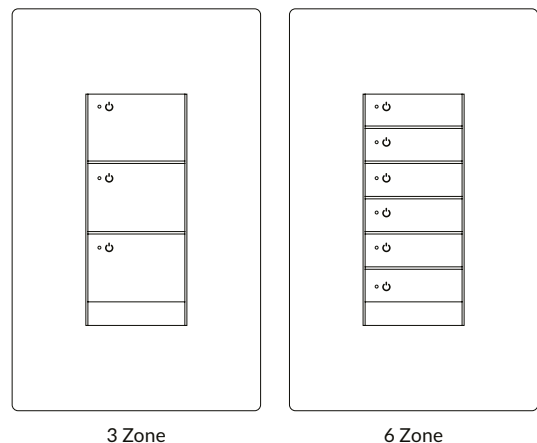

## Ordering Information

### GreenBus Wired Wallstations

Catalog Number	Description	Approbation	Communication Network	Modifiers
EN-WS-ZC3-GB2-WH	ZC Series Wallstation, 3 Zone	UL	GreenBus	White – WH
EN-WS-ZC3-GB2-IV	ZC Series Wallstation, 3 Zone	UL	GreenBus	Ivory – IV
EN-WS-ZC3-GB2-GR	ZC Series Wallstation, 3 Zone	UL	GreenBus	Gray – GR
EN-WS-ZC3-GB2-BL	ZC Series Wallstation, 3 Zone	UL	GreenBus	Black – BL
EN-WS-ZC6-GB2-WH	ZC Series Wallstation, 6 Zone	UL	GreenBus	White – WH
EN-WS-ZC6-GB2-IV	ZC Series Wallstation, 6 Zone	UL	GreenBus	Ivory – IV
EN-WS-ZC6-GB2-GR	ZC Series Wallstation, 6 Zone	UL	GreenBus	Gray – GR
EN-WS-ZC6-GB2-BL	ZC Series Wallstation, 6 Zone	UL	GreenBus	Black – BL

### Wireless Wallstations

Catalog Number	Description	Approbations	Communication Network	Modifiers
EN-WS-ZC3-ZB-WH	ZC Series Wallstation, 3 Zone	UL and CE	Wireless	White – WH
EN-WS-ZC3-ZB-IV	ZC Series Wallstation, 3 Zone	UL and CE	Wireless	Ivory – IV
EN-WS-ZC3-ZB-GR	ZC Series Wallstation, 3 Zone	UL and CE	Wireless	Gray – GR
EN-WS-ZC3-ZB-BL	ZC Series Wallstation, 3 Zone	UL and CE	Wireless	Black – BL
EN-WS-ZC6-ZB-WH	ZC Series Wallstation, 6 Zone	UL and CE	Wireless	White – WH
EN-WS-ZC6-ZB-IV	ZC Series Wallstation, 6 Zone	UL and CE	Wireless	Ivory – IV
EN-WS-ZC6-ZB-GR	ZC Series Wallstation, 6 Zone	UL and CE	Wireless	Gray – GR
EN-WS-ZC6-ZB-BL	ZC Series Wallstation, 6 Zone	UL and CE	Wireless	Black – BL

### Surface-Mount Kit

Catalog Number	Description	Approbations	Communication Network	Modifiers
EN-SMK-ZB-WH	Surface Mount Kit	UL and CE	Wireless	White – WH

## Wired System Overview

GreenBus technology makes wiring fast and error-free, since it's intuitive to install. With any Encelium X wired design, you get a reliable, lighting control system that can be installed quickly and easily.

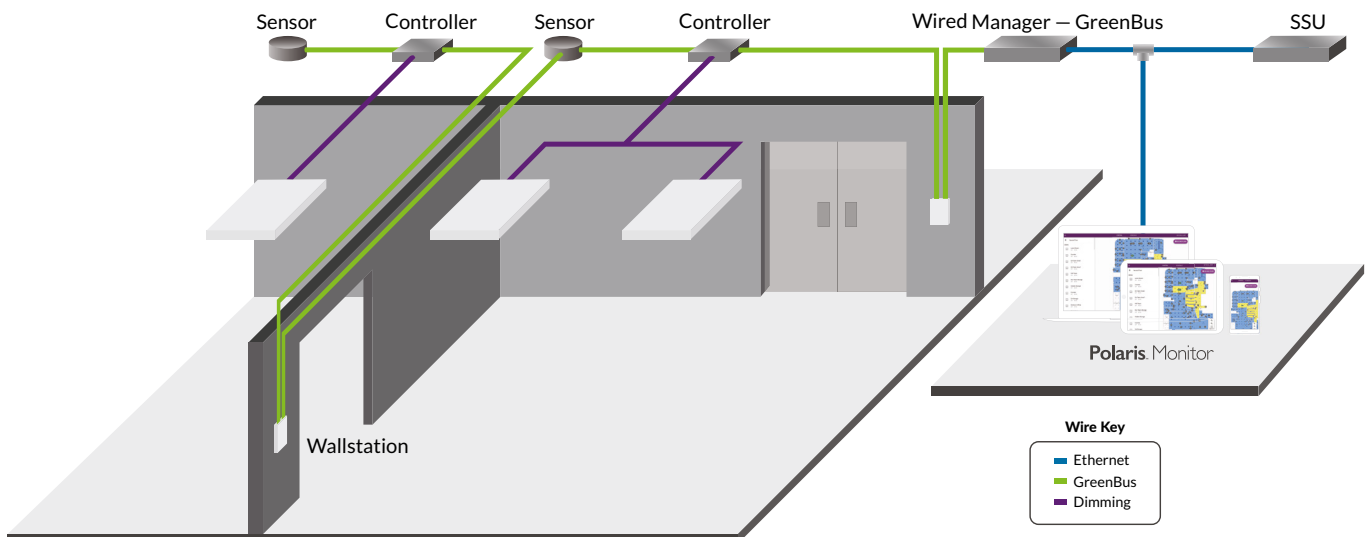

## Wireless System Overview

This illustration shows how each component is easily integrated into the Encelium X Lighting Control System.

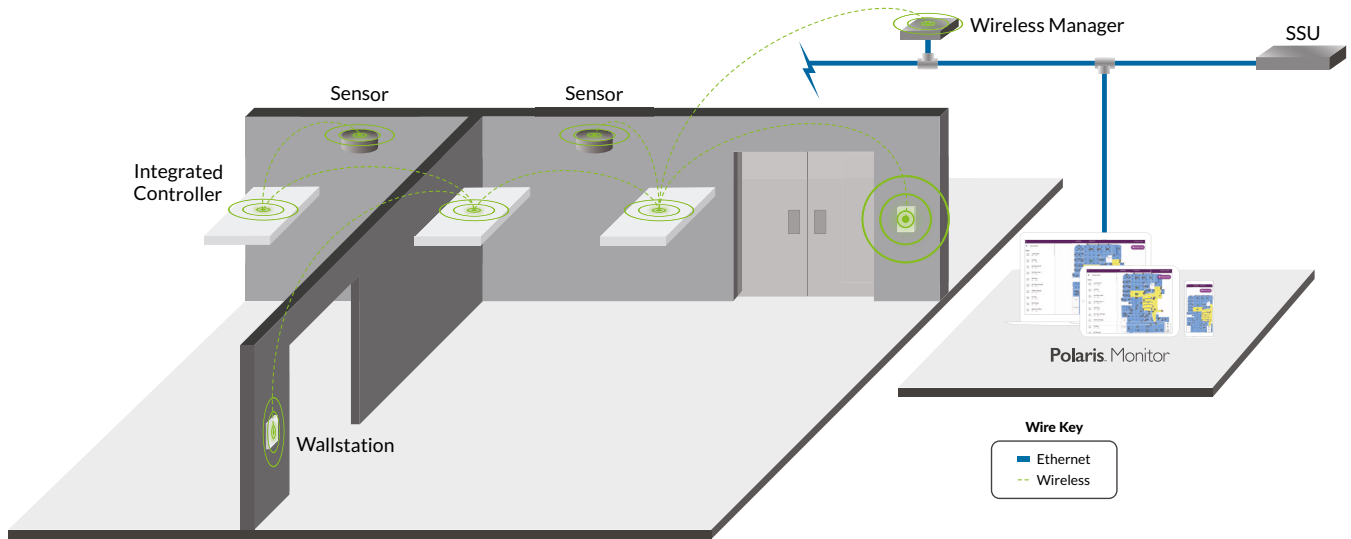

## Wiring Diagrams

### GreenBus Wired Wallstation Wiring

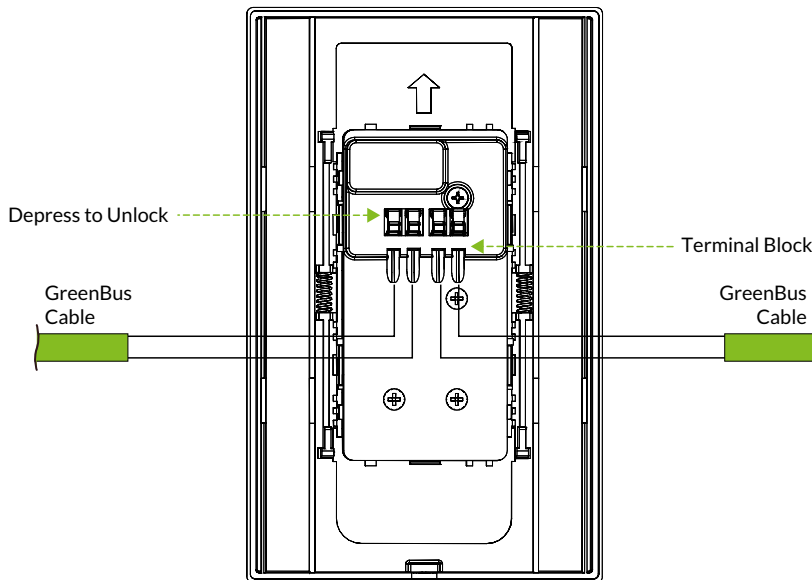

## Wiring Diagrams (cont.)

### Wireless Wallstation – Battery Operated, No Wiring Required

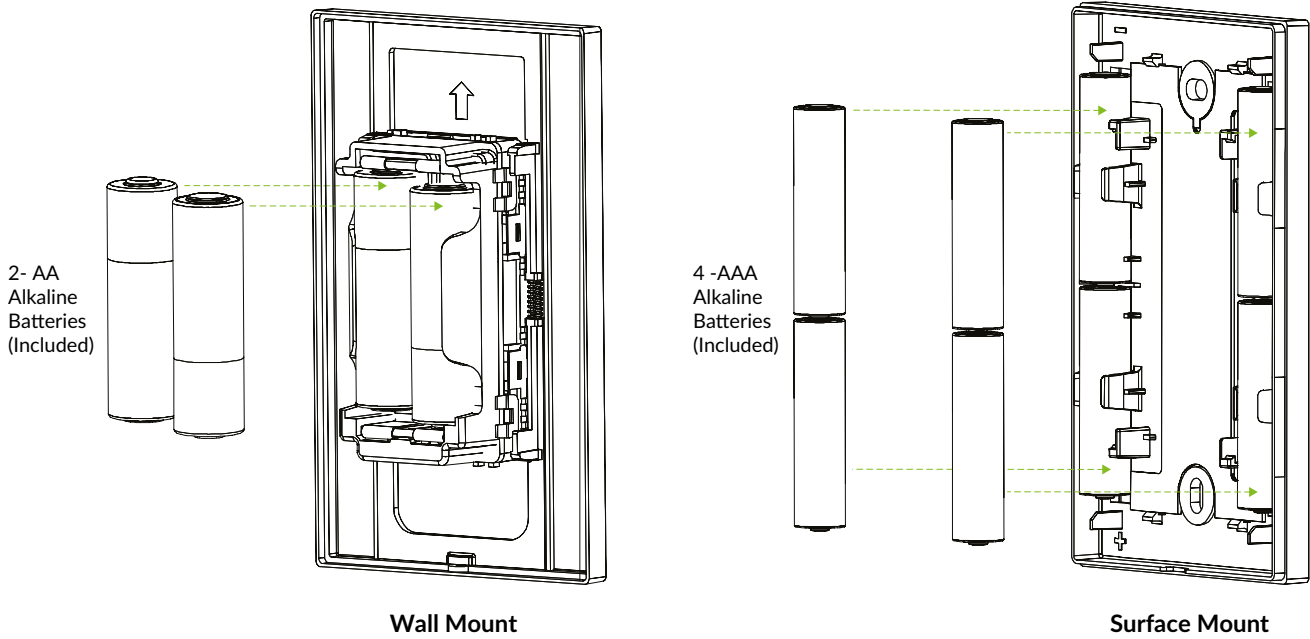

## Mounting Options

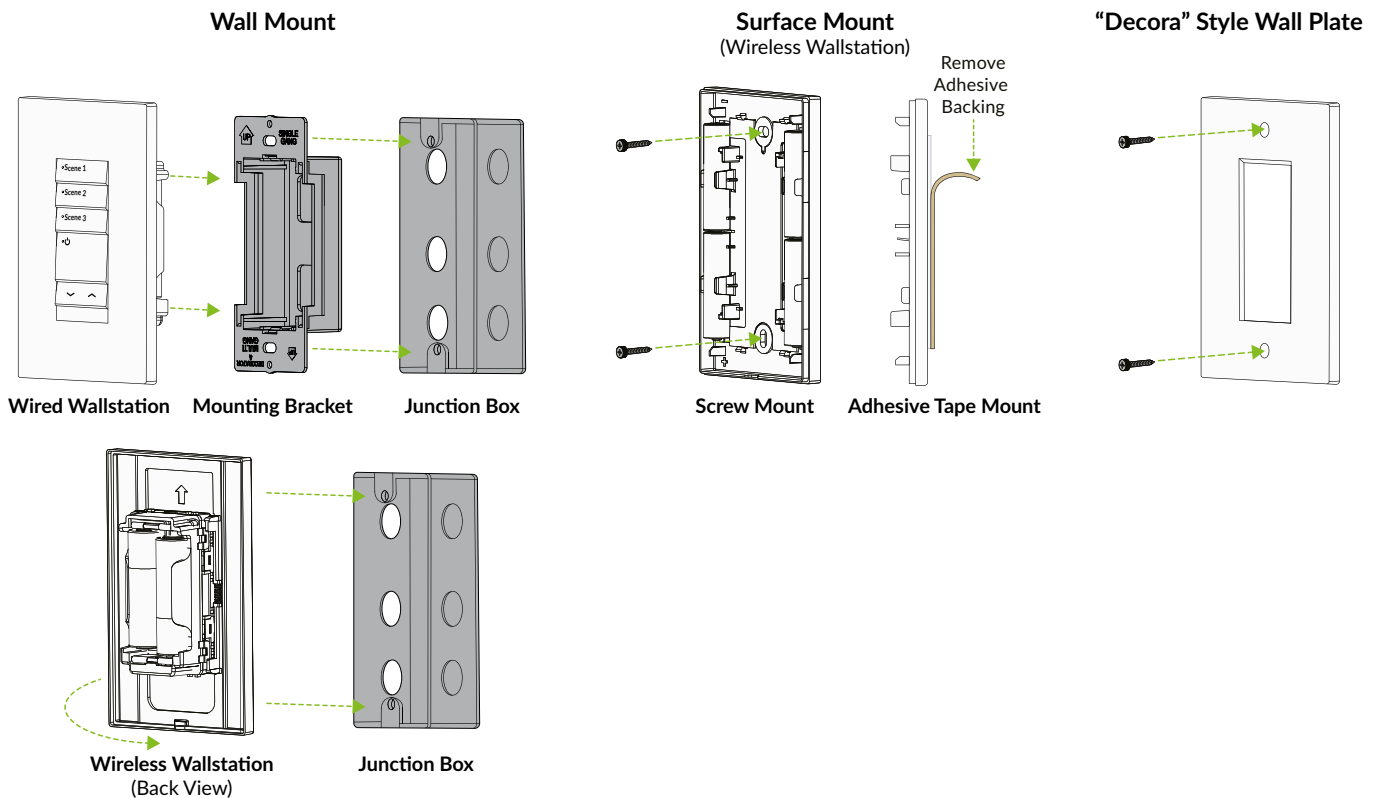

## Button Kit Ordering Information

The button kit provides the ability for field replacement. Each part number comes with the three button kits shown to allow flexibility to replace buttons on an existing wallstation.

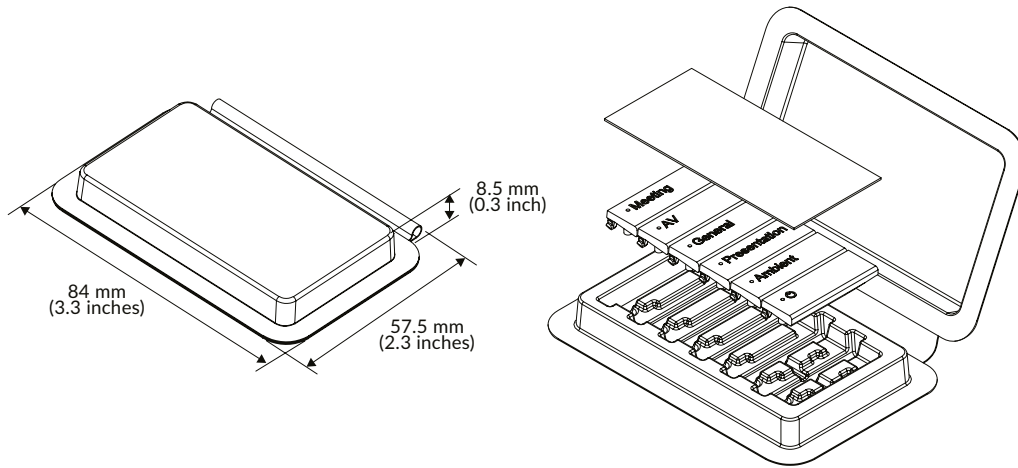

<sup>2</sup> Custom engraving kits are available. For more information contact your local sales representative.

Catalog Number	Description	Approbations	Buttons	Modifiers
EN-BLANK-BT01-DH-WH	ZC Series Wallstation, Blank, 3 Button Kit	UL and CE	3 sets of 3 Double Height Buttons	White - WH
EN-SH-BT01-ZC3-WH	SHS Wallstation, 3 Scene Button Kit	UL	3 - Shade Control Buttons	White - WH
EN-TW-BT01-ZC3-WH	TW Wallstation, 3 Scene Button Kit	UL and CE	3 - Tunable-White Buttons	White - WH