



## Product datasheet

### Technical data

#### Electrical data

Nominal voltage	230 V
Mains frequency	50 Hz
System wattage	0.30 W

#### Dimensions & weight

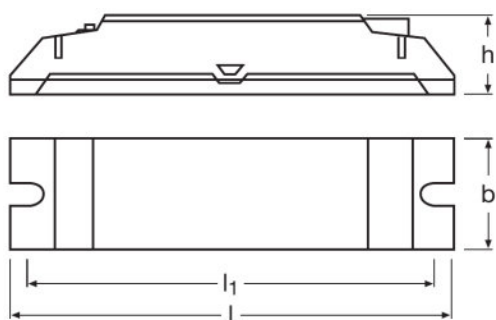

Length	118.0 mm
Width	30.0 mm
Height	21.0 mm
Product weight	50.00 g

#### Capabilities

Dimmable	No
Dimming interface	DALI
Type of installation	Luminaire integration/Ceiling integration

#### Certificates & standards

Type of protection	IP20
--------------------	------

#### Logistical data







Commodity code	853710989900
----------------	--------------

### Equipment / Accessories

- Separate installation possible with ECO CI KIT
- Suitable for many OSRAM DALI control systems

## Product datasheet

### Download Data

File	
	User instruction DALI Sensor Coupler HF LS LI
	Brochures Light is the efficiency booster - LED-based industrial lighting (EN)
	Brochures Light is the efficiency booster - LED-based industrial lighting (DE)
	Declarations of conformity 538499_CE declaration DALI Professional System
	Installation guide 538505_Manual DALI Sensor Coupler HF LS LI
	CAD data 3-dim DALI Sensor Coupler HF LS LI - CAD DATA
	CAD data PDF DALI Sensor Coupler CAD pdf

### Logistical Data

Product code	Product description	Packaging unit (Pieces/Unit)	Dimensions (length x width x height)	Volume	Gross weight
4052899141728	DALI Sensor Coupler HF LS LI	Shipping carton box 25	200 mm x 140 mm x 147 mm	4.12 dm <sup>3</sup>	1670.00 g

The mentioned product code describes the smallest quantity unit which can be ordered. One shipping unit can contain one or more single products. When placing an order, for the quantity please enter single or multiples of a shipping unit.

### Disclaimer

Subject to change without notice. Errors and omission excepted. Always make sure to use the most recent release.