

## DALI LS/PD LI

### DALI LS/PD LI | Sensors



#### Product family features

- Direct connection to DALI
- Light and presence sensor for luminaire installation
- Presence detection via passive IR element
- Light sensor operating range: 20...800 lx (measured at sensor)
- Function indicator with two-color LED
- Mounting height: 2...5 m

#### Product family benefits

- Small housing design
- Presence detection angle adjustable between 40...90° via integrated shutters

#### Areas of application

- Installation in industry and office luminaires
- Ceiling installation via LS/PD CI KIT or LS/PD AP KIT possible

## Product datasheet

### Technical data

#### Dimensions & weight

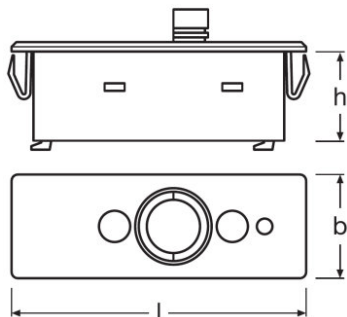

Length	48.0 mm
Width	15.0 mm
Height	17.0 mm
Product weight	10.00 g

#### Temperatures & operating conditions

Ambient temperature range	-20...+50 °C
---------------------------	--------------

#### Capabilities

Dimmable	No
Maximum installation height	5 m
Detection area	6 m <sup>1)</sup>
Detection angle	80 °
Operating range, light sensor	20...800 lx
Type of installation	Ceiling integration/Luminaire integration

<sup>1)</sup> Maximum diameter

#### Certificates & standards

Type of protection	IP20
--------------------	------

#### Logistical data











Commodity code	853650199000
----------------	--------------

## Product datasheet

### Equipment / Accessories

- Suitable for DALI Professional and DALIeco Control unit
- Attachable mounting frame for luminaire mounting from inside and outside

### Download Data

File	
	User instruction DALI LSPD LI
	Declarations of conformity EC-DoC LMS Sensor Coupler and Sensor 9C1-3402820-EN-02 2019
	Declarations of conformity 334811_Declaration of conformity &#150; DALI PRO CONT-4 &#150; DALI PRO PB Coupler &#150; DALI PRO Sen
	Declarations of conformity EU Declaration of Conformity 2019_9C1_2874588_EN_09
	Operating instructions 377128_Manual DALI LSPD LI (D-EN-ES-FR-IT)
	Operating instructions 383606_Manual DALI LSPD LI (PL-CZ-SK-SL)
	Operating instructions 383607_Manual DALI LSPD LI (FI-DK-NO-SV)
	CAD data DALI LSPD LI CAD Data
	CAD data 3-dim DALI LS PD LI CAD Step
	CAD data 3-dim DALI LS PD LI CAD X_T

### Logistical Data

Product code	Product description	Packaging unit (Pieces/Unit)	Dimensions (length x width x height)	Volume	Gross weight
4052899043954	DALI LS/PD LI	Shipping carton box 25	223 mm x 197 mm x 179 mm	7.86 dm <sup>3</sup>	1131.00 g

The mentioned product code describes the smallest quantity unit which can be ordered. One shipping unit can contain one or more single products. When placing an order, for the quantity please enter single or multiples of a shipping unit.

## Product datasheet

---

### Disclaimer

Subject to change without notice. Errors and omission excepted. Always make sure to use the most recent release.