

GBS

GreenBus Wired Sensors

Date: _____

Quantity: _____

Company: _____

Project: _____



The **GBS (GreenBus™ Wired Sensors)** family of ceiling/surface mount sensors provides a range of networked sensor solutions for applications with finished ceilings (e.g. ceiling tiles, sheet rock, plaster). They combine Passive Infrared (PIR) and Photocell sensing in a single compact form factor.

The GBS family is available with several lens options, providing flexibility for multiple mounting heights and coverage pattern requirements.

This sensor family easily connects to the Encelium X Light Management System through a GreenBus cable with standard 2-pin connectors, and feature tool-less mounting options for easy installation, and provides masking options to maximize control flexibility.

Works with

- Encelium X
 - ▶ GreenBus Wired



Key Features & Benefits

- Available in three coverage options – 42 sq m (450 sq ft), 140 sq m (1,500 sq ft), and high-bay option
- Multiple mounting options available including magnetic mount on T-bar
- Enables contractors to quickly test wired installations
- Use in wireless installations for a battery-less solution

Specifications

SENSING AND CONTROL

Sensing

- Passive Infrared (PIR) Sensor
- Photo Sensor

Light Sensor Operating Range

- 0 to 1,000 lux

Control

- GreenBus Communication

ELECTRICAL

Power Supply Operating Voltage

- 12-24V from GreenBus bus

Sensor Current Draw

- 3 mA

ENVIRONMENTAL

Operating Temperature

- Standard Range (SR) and Extended Range (ER) Sensors
0° – 40°C (32° – 104°F)
- High Bay (HB) Sensor
0° – 60°C (32° – 140°F)

Relative Humidity

- 0% – 95% non-condensing, for indoor use only

PHYSICAL

Base Diameter

- 85.49 mm (3.37 inches)

Height

- 28.6 mm (1.13 inches) – SR sensor
- 26.2 mm (1.03 inches) – ER and HB sensors

Weight

- 81 g (2.8 oz)

Dimensions

Housing Color

- Matte White

Housing Material

- UV stabilized plastic

Mounting Options

- Magnetic Mount
- Surface Mount
- Ceiling Tile Mount (requires optional mounting accessory kit)
- Junction Box Mount (requires optional mounting accessory kit)
- Shields included (no opening of sensor required)

Mounting Height

- 2.4 – 3.7 m (8 – 10 ft) for SR and ER sensors
- Up to 12 m (40 ft) – HB Sensor
- Additional mounting accessory kit provided in product packaging

WARRANTY

- Standard warranty is in effect for a period of five (5) years from the date of shipment.¹

CERTIFICATIONS & SAFETY

Approbations

- cUL Listed (UL 916)
- FCC Part 15/ICES-003
- RoHS Compliant
- Meets ASHRAE Standard 90.1 and CEC Title 24 requirements



GreenBus[®]

Standard Range Sensor

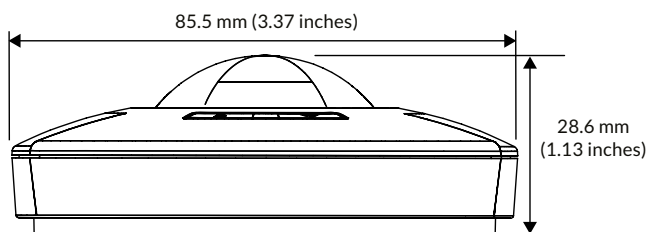

Extended Range Sensor
High-Bay Sensor

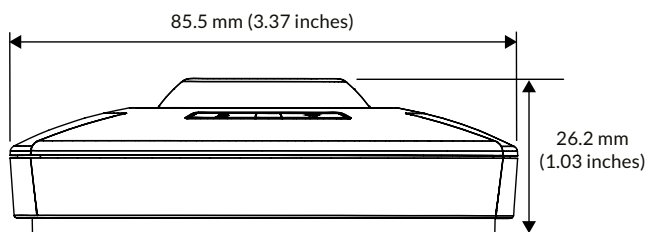

Footnotes:

¹ This does not apply to: (1) damage caused by accident, mishandling, or dropping; (2) materials which have been subject to unauthorized repair; (3) materials not used in accordance with instructions; (4) ordinary wear and tear.

Ordering Information

Catalog Number	Description	Approbation	Sensing Technologies	Coverage	Sensing Angle
EN-SCPPH-0450-GB2	GreenBus Wired Sensor	UL	PIR/Photo	450 ft ² (42 m ²)*	360°
EN-SCPPH-1500-GB2	GreenBus Wired Sensor	UL	PIR/Photo	1,500 ft ² (140 m ²)*	360°
EN-SCPPH-HB-GB2	GreenBus Wired Sensor	UL	PIR/Photo	See Notes**	360°
EN-SCPPH-MK-ZB	Mounting Accessory Kit	UL	—	—	—

* Mounting Height: 2.4 – 3.7 m (8 – 12 ft) ** Dependent on mounting height

Sensor Mounting Height

Mounting Height	Coverage
6 m (20 ft)	102 m ² (~1,100 ft ²)
9 m (30 ft)	167 m ² (~1,800 ft ²)
12 m (40 ft)	260 m ² (~2,800 ft ²)

Sensor Coverage

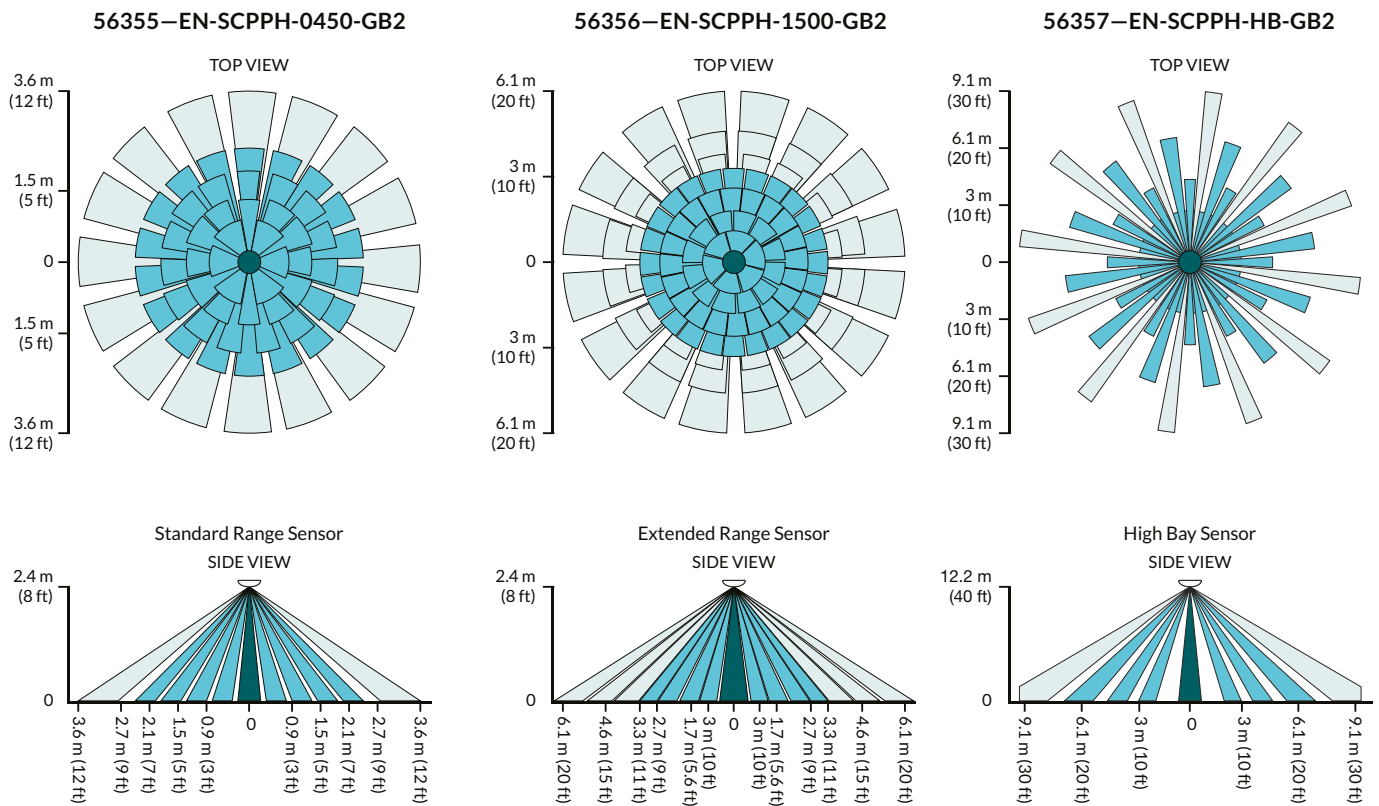

Wired System Overview

GreenBus technology makes wiring fast and error-free, since it's intuitive to install. With Encelium X, you can control DALI devices exclusively or a mixture of GreenBus and DALI. With any Encelium wired design, you get a reliable, on-site light management system that can be installed quickly and easily.

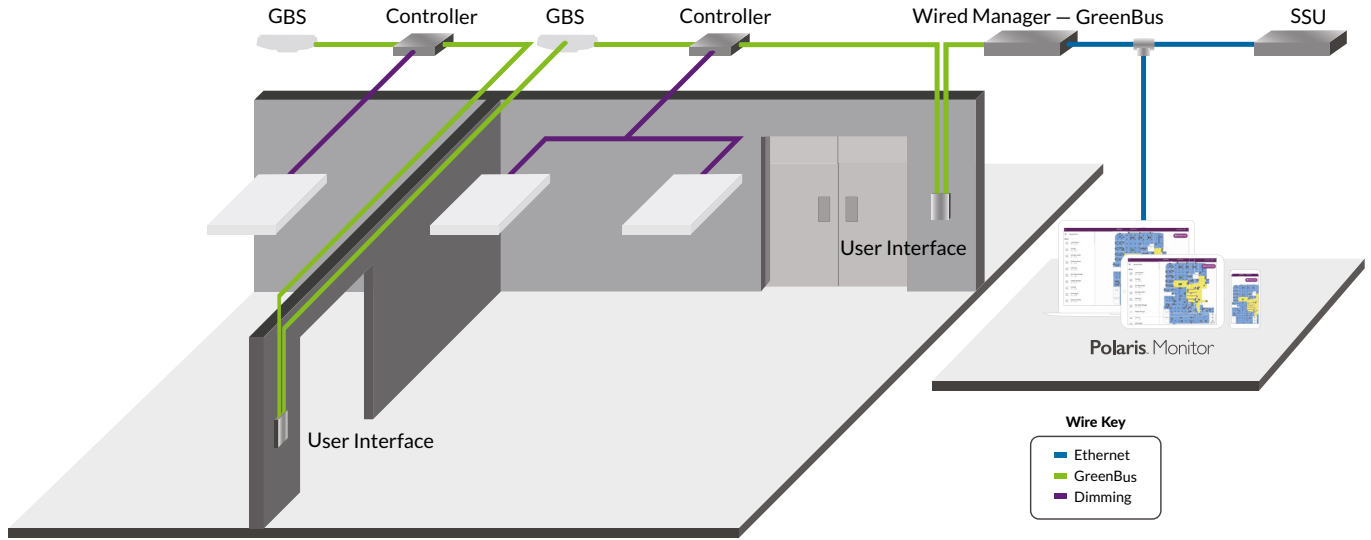

Wiring Diagram

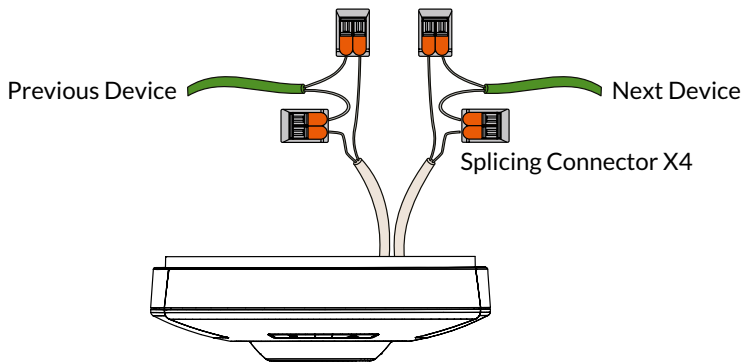

Mounting Options

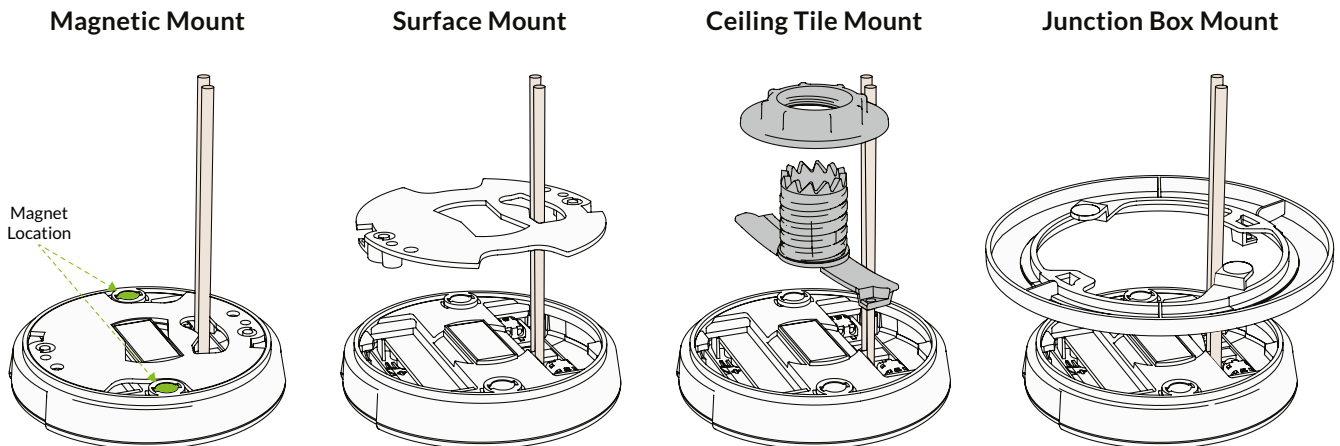

Ceiling Tile Mount and Junction Box Mount requires optional mounting kit (sold separately).

Installation Testing

Installer can quickly test if the devices have been wired correctly by pressing any button on the wallstation or the sensor which triggers all the load controllers on the channel to change the dimming level by 25%. Every press will trigger this function to enable testing of the AC line wiring, dimming wiring, and communication integrity over the GreenBus lines.

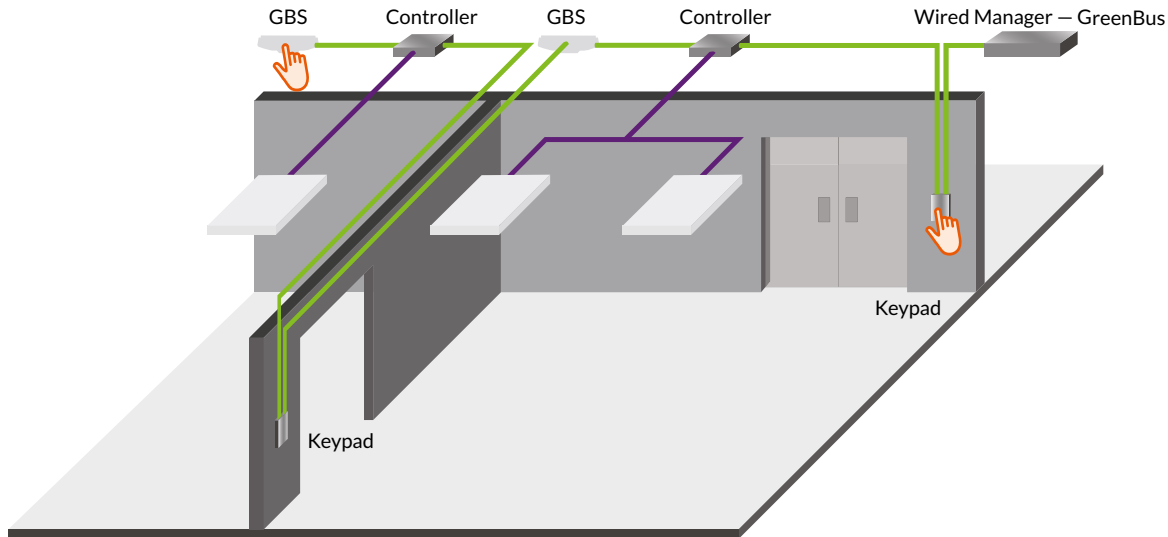

Manual Pairing

Installers can easily pair devices in a room or a zone to gain manual control (on, off and dimming) and occupancy time outs. Holding any buttons on a wallstation or sensor for 10 seconds enters the system in the Manual Pairing mode. The system then guides the user by blinking the load controllers on the GreenBus wiring scheme as a means of identifying and pairing them to the wallstation or sensor.

